



Manual for STE2 PLUS

Safety warning

The device has been tested and is in good working condition, meeting the standards required in the Czech Republic.

To keep it working properly, it's important to follow the safety and maintenance guidelines listed below. If the device is used improperly, it may not work safely.

Also, make sure that the power socket or the point where the device can be unplugged from the power supply is easy to reach.

Do not use the device if:

- It looks damaged
- It's not working properly
- There are loose parts inside
- It was exposed to moisture or water for a long time
- Someone who is not authorized tried to repair it
- The power adapter or its cable looks damaged
- You're using the device in a way that's not recommended, which may compromise its safety features
- The switch, fuse, and other power surge protection features must be part of the device's overall construction.

The manufacturer is only responsible for the device if it's being powered by an approved or supplied power source.

If you experience any difficulties with installing or starting up the device, please don't hesitate to reach out to our technical support team for assistance.

HW group s.r.o.

<http://www.hw-group.com>

email: support@HWg.cz

Rumunská 26/122

Prague, 120 00

Phone: +420 222 511 918

Before contacting technical support, prepare a precise model of your device (on the manufacturing label and the firmware version (see below), if you know it.

Contents

Safety warning	2
Product usage scheme	5
Basic features	6
Connectors and wiring	7
Recommended connection	9
First start-up	13
WWW interface	16
- Home tab.....	16
- Security tab	20
- WiFi tab.....	21
- Sensor tab	24
- Hysteresis.....	27
- Digital Inputs tab	28
- Outputs tab.....	29
- Email tab	30
- SMS tab	32
- Alarms tab	33
- SNMP tab.....	36
- Time tab.....	39
- Portal tab.....	40
- System tab	44
Technical parameters	47
- Physical dimensions.....	48
- WiFi Radio.....	50
- WiFi signal strength	50
Supported interfaces	52
- Digital Inputs	52
- Sensors RJ11 (1W-UNI bus).....	53
Connecting STE2 to the SensDesk portal	55
HWg Monitor - mobile app	60
Firmware upgrade in STE2 PLUS units	62

STE2 PLUS

STE2 PLUS is a professional LAN & WiFi remote sensor monitoring product.

High security is available with SNMPv3, HTTPS custom certificates and IPv6. External sensors (15 values) for 2× RJ11 ports & detectors to 2× DI (Digital Input).

Whenever a too high or too low temperature is detected (door opened), an Alert is sent. STE2 PLUS also supports SNMP Traps. Alerts (Emails) can be sent directly from the device (SMTP) or via the Portal service (SMS, ring-out, and device disconnected alerts).

Even without Portal service, the device can send alerts via an external SMS gateway device (on the same network). With or without the Portal, the HWg monitor (iOS/Android mobile application) displays current sensor values.

Additional sensors can be connected to a second RJ11 sensor port (%RH, Cryo temperatures, CO₂, VoC, 4-20mA, water flood, ...). RJ11 sensors can be daisy chained or one physical sensor can measure several values (°C + %RH + VoC = 3 values). With VDO (Virtual Digital Outputs), external relay outputs can be controlled based on the sensor value.

Device package contains (international) wall plug power adapter 5V and 3m RJ11 temperature sensor. Device can be powered by PoE.



Product usage scheme

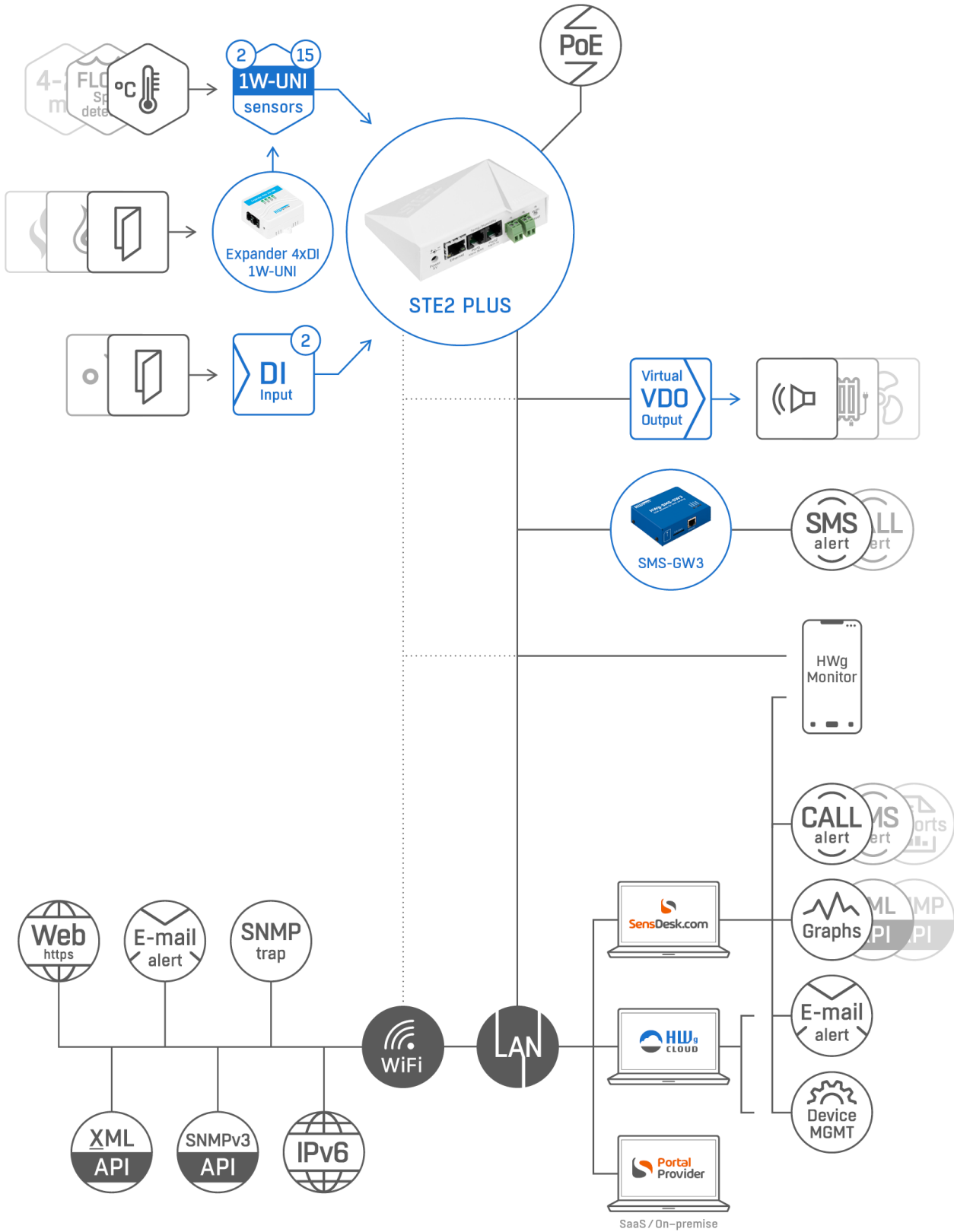

Basic features

- The device supports LAN and WiFi connections via 802.11 b/g/n (2.4 GHz).
- It supports Ethernet and WiFi operation for easy configuration.
- The device can be powered by 5V (external power adaptor) or PoE.
- The device comes with a built-in WEB server that supports HTTPS. Standard Internet browser is enough for configuration.
- Open API: It can be connected to higher-level monitoring systems via XML or SNMP.
- The device can handle HTTP and HTTPS traffic simultaneously, with the option to disable one or both protocols for security reasons.
- If the sensor value (temperature) goes out of Safe Range, the device can send an email as an alert.
- The device supports TLS authorization (Gmail...) and is password protected.
- Supports Alarms reminder period for alarm escalation and Periodic status as a feature Heartbeat.

Application

AC (Air Conditioning) failure

Changes in temperature alert you of the A/C cooling unit outages.

Heating monitoring

Remote monitoring of the heating system, email or SMS alerts of freezing hazards.

Monitoring of services provided

Easily create reports with temperature graphs at one or more locations via the Portal service. You can keep an eye on the quality of the outsourced services.

Refrigerator or freezer monitoring

Sends an email when your refrigerator fails. Logging of operating and storage conditions.

Heating optimization

Save on heating and air conditioning costs.

Food storage

Monitors optimal storage conditions. HACCP protocols can be created using the SensDesk Report feature (optional).

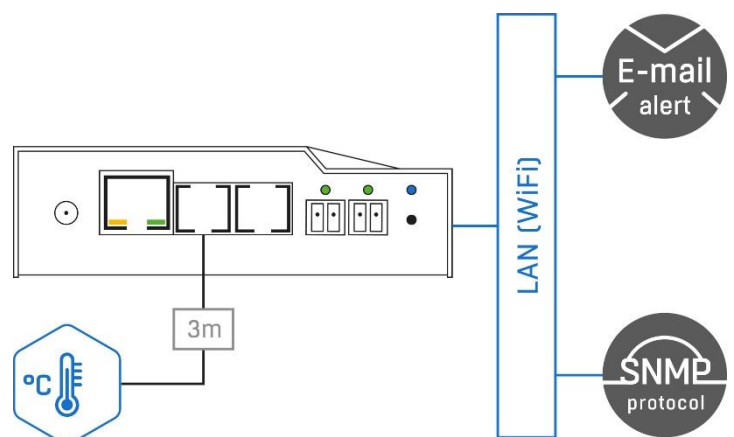

Connectors and wiring

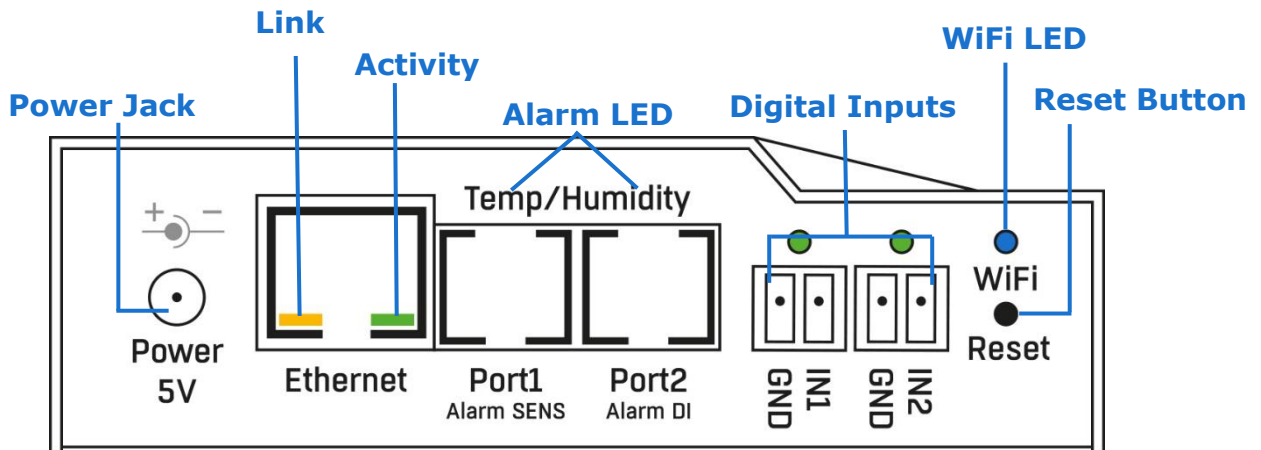

- **Ethernet** - LAN connectivity, default configuration also for WiFi connectivity.
- **2x RJ11 (Temp/Humidity)** - External RJ11 sensors from HW group.
 - Each port is max. 60m.
 - One physical sensor can provide several sensor values.
 - Temperature & Humidity sensor provides 2 sensor values.
 - Sensor values limit is for both RJ11 ports together.
- **Power** - 5V power supply (external adapter).

Indication

- **Digital Inputs** - Lighting when DI = 1(On).
- **Link** - A yellow LED signalizes connectivity to the computer network.
- **Activity** - A green flashing LED signalizes ongoing communication.
- **WiFi** - A blue LED signalizes connection to the WiFi AP.
- **Alarm LED** - Two LEDs hidden in the Port1 and Port2 connectors.
 - **Alarm SENS** - LED signal Alarm state on any of sensors.
 - **Alarm DI** - LED signal Alarm state on one of DI (Digital Input).

Button

- **Reset** - serves to restore factory settings on the device.
 - 1) Switch the device off.
 - 2) Press and hold the button.
 - 3) Switch the device on and press the button for another 5 seconds.
 - 4) All the LEDs will gradually light up.
 - 5) Restart the device. Factory settings will be restored.

	STE2 LITE	STE2 R2	STE2 PLUS
Ethernet	10/100Mbit	10/100Mbit	10/100Mbit
WiFi	IEEE 802.11bgn	IEEE 802.11bgn	IEEE 802.11bgn
IPv6	-	-	YES
SNMP	v1	v1	v1 + v3
SNMP Trap	-	-	YES
DHCP	YES	YES	YES
HTTP	YES	YES	YES
HTTPS	YES	YES	YES
XML	YES	YES	YES
SMTP	YES	YES	YES
SMTP TLS	YES	YES	YES
HWg-Push (SensDesk)	YES	YES	YES
Net-GSM (SMS GW)	YES	YES	YES
Syslog	--	-	YES
Sensors			
1-Wire sensor values	Max 4	Max 5	Max 15
1-Wire UNI	YES	YES	YES
DI (Digital Inputs)	-	2	2
DO (Outputs)	-	-	8 VDO Virtual Digital Outputs
Alarms			
Email destinations	2	5	5
Trap destinations	-	-	5
SMS - destinations	2	5	5
Alarm reminder	-	-	YES
Periodical status	-	-	YES
Power and dimensions			
Power supply	5V / 300 mA	5V / 300 mA	5V / 300 mA
Connector	Jack (barrel, 1.35 / 3.5 mm)	Jack (barrel, inner 1.35 mm outer 3.5 mm)	Jack (barrel, inner 1.35 mm outer 3.5 mm)
PoE	-	YES	YES
PoE Current	-	60 mA	60 mA
PoE class	-	IEEE 802.3af Class 0	IEEE 802.3af Class 0
Operating / Storage	-30°C to 60°C 0% RH to 95% RH	-30°C to 60°C 0% RH to 95% RH	-30°C to 60°C 0% RH to 95% RH
Weight	85 g	91 g	91 g
Dimensions	68x63x32 mm	98x68x33 mm	98x68x33 mm
Environment	SoHo, IT	SoHo, IT	SoHo, IT
Installation	Table	DIN, Table, Wall	DIN, Table, Wall
Protection	IP40	IP40	IP40

Recommended connection

STE2 R2

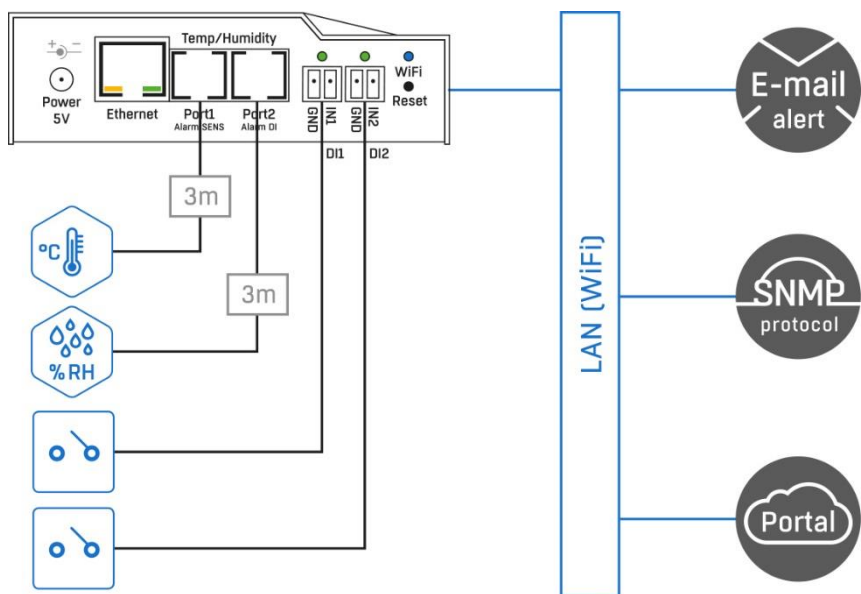
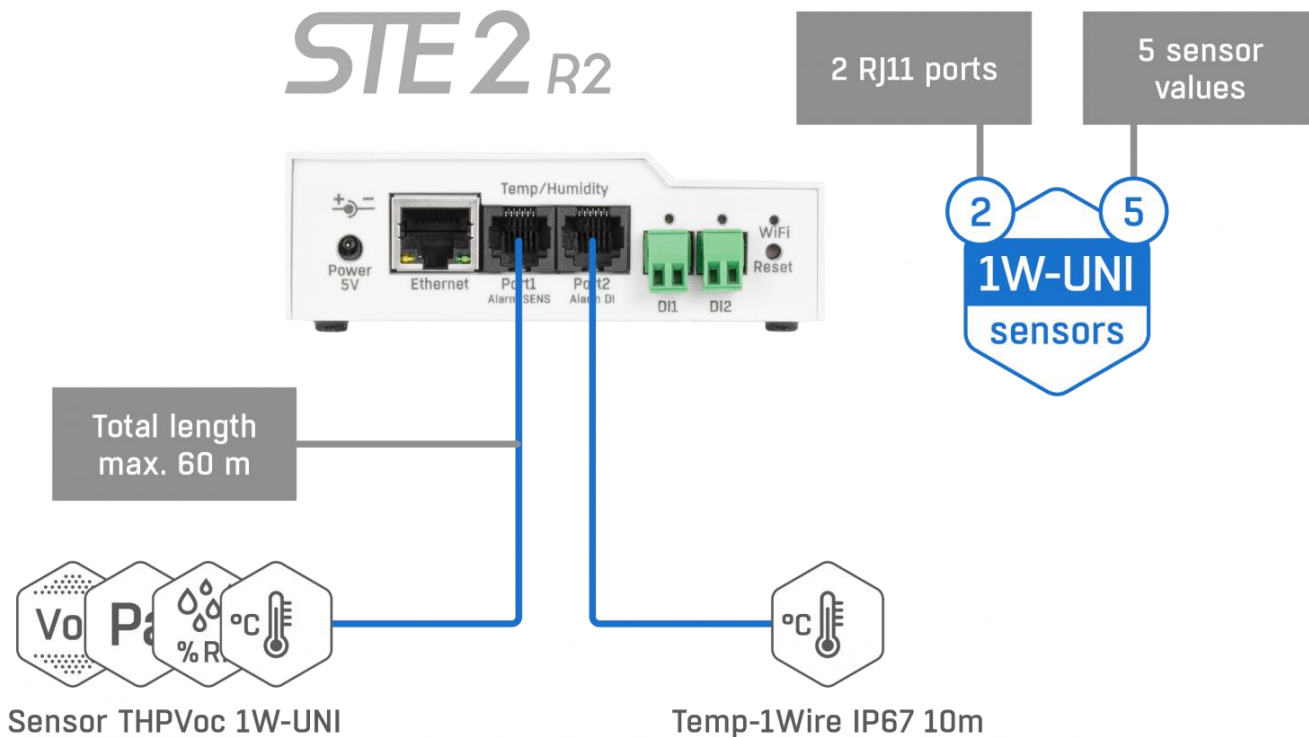

STE2 PLUS

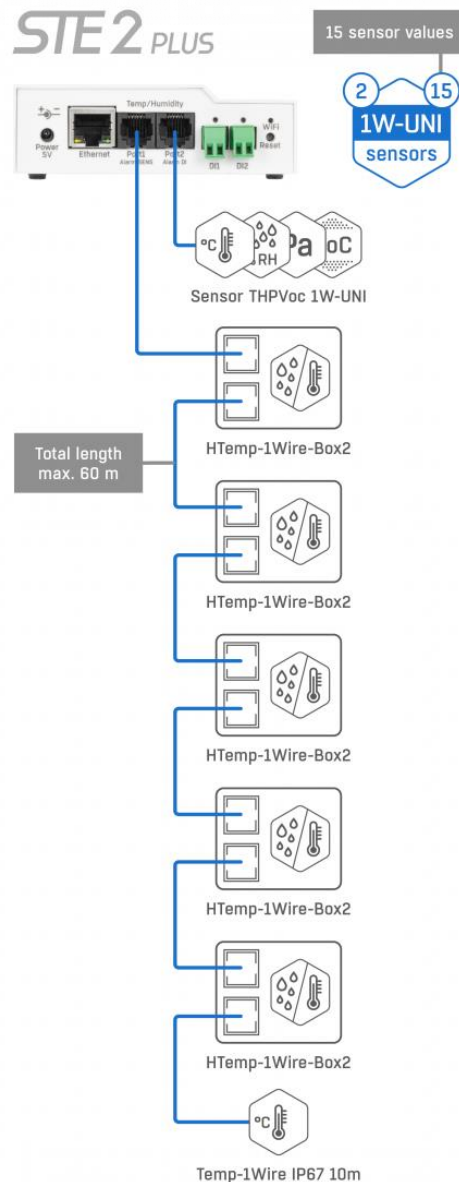



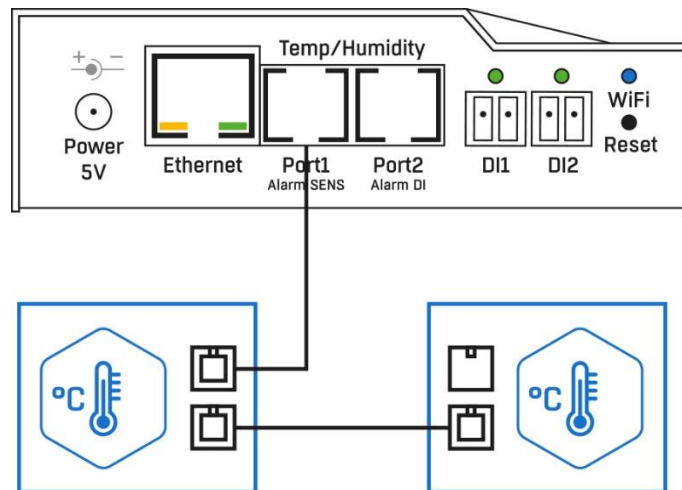
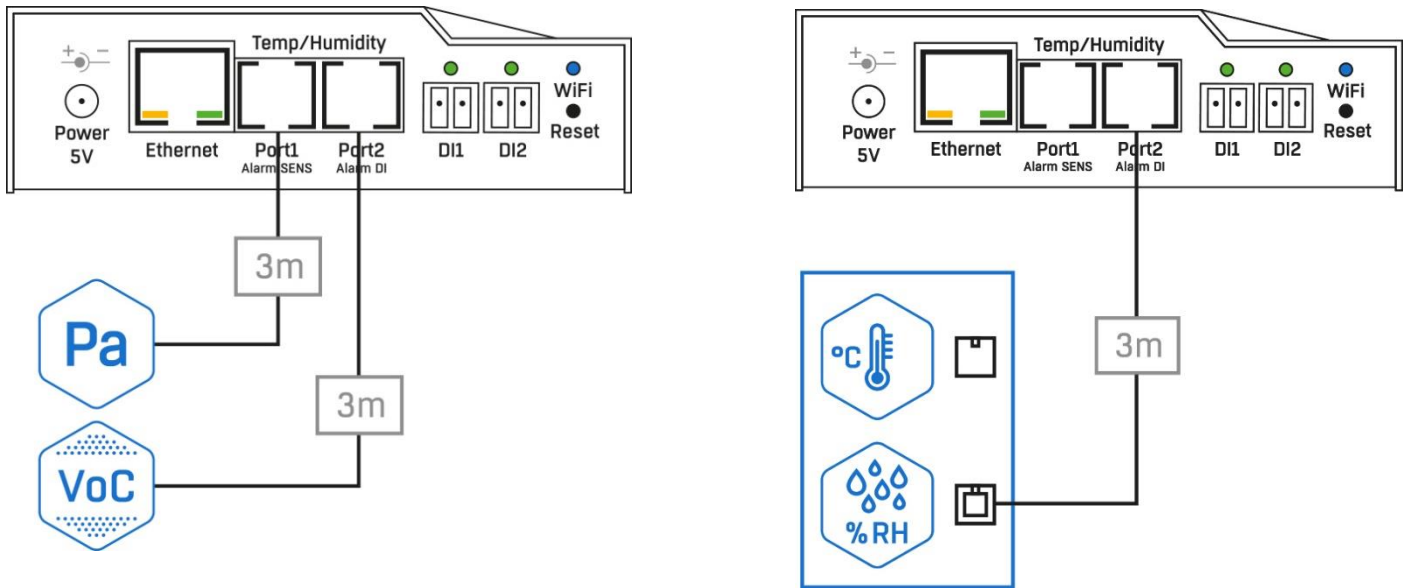



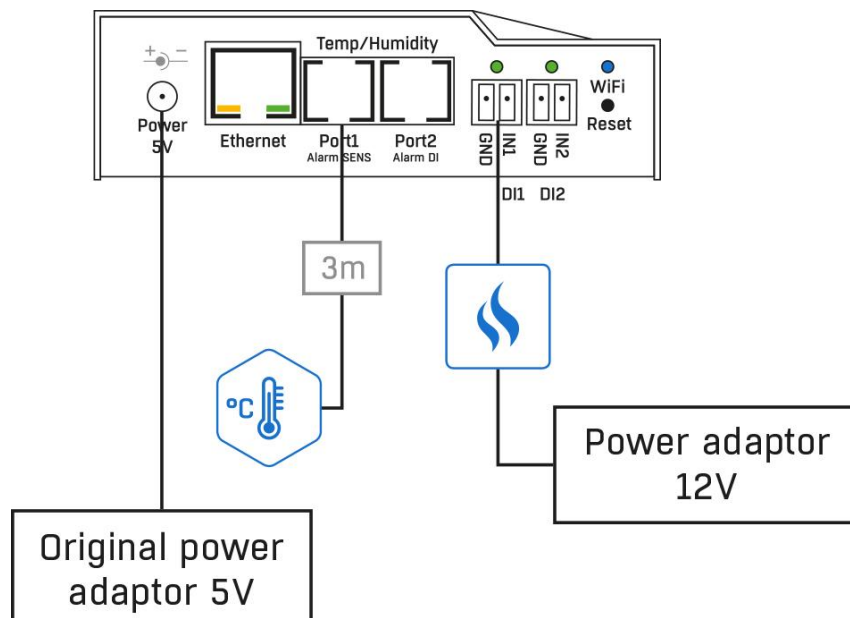



RJ11 sensor connection options:



Smoke detector connection:













Compatible sensors

-  Atmospheric Pressure
-  Light Intensity
-  Air Quality CO₂
-  Air Quality VoC
-  Temperature
-  Dew Point
-  AC / DC Voltage
-  Current interface
-  Water Spot detection
-  AC / DC Current
-  Relative Humidity

And many more available at HW group website in [Products](#) - [Sensors](#) section.



Compatible detectors

-  Smoke detection
-  Vibration detection
-  Air flow detection
-  Power presence detection
-  Gas detection
-  230V presence detection
-  Door contact detection
-  Motion detection
-  Dry contact state detection
-  S0 pulse counter

And many more available at HW group website in [Products](#) - [Detectors](#) section.



Remote Monitoring Ecosystem

HW group company is a manufacturer of the **Remote Monitoring Ecosystem**. Our devices, sensors and detectors could be combined into large industrial-grade, secure and reliable projects connected to the SensDesk Portal Technology.

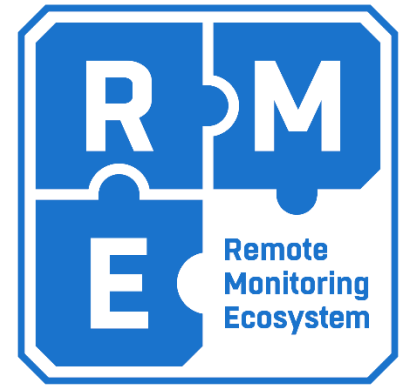

SMS-GW is a central gateway that allows HWg devices, SensDesk portals, and third-party software/hardware to send text messages (SMS) and make voice calls alerts. Its main use is when customers have multiple HWg devices for remote monitoring. They can all connect to a single SMS-GW to send alarm alerts (SMS/voice calls) to different phone numbers.



- [SMS-GW3 \(GSM/2G\)](#)
- [SMS-GW3 LTE](#)

The **HWg-cloud.com** is a Portal (on-line service) from the HW group company to manage remote monitoring devices. It sends email alerts, displays graphs of sensor values, and helps with device management. You can use www.HWg-cloud.com for free, but it only works with sensors made by HW group company.



- [Free of charge Portal service](#)

The **SensDesk Technology** is a portal solution from the HW group to manage remote sensors and devices (only for HW group products), allowing central overview of all the values, sending the alarms, reporting, outputs into the Open API, etc.



- [SensDesk.com 5D/10D/25D subscription](#)

The **UPS 12V and 5V** is a backup power source for devices with 12V as well as 5V DC power supply which can be powered by the UPS simultaneously. Apart from a stable output voltage of 12V up to 1.5A and 5V up to 0.5A it provides information of external power supply outage as well as of the detailed UPS status to compatible HW group monitoring devices via the 1-Wire UNI output.



- [UPS 12V](#)
- [UPS 12V and 5V](#)

First start-up

1) Cable connection

- Connect the device to the **Ethernet** (direct cable to the switch, crossed to PC).
- Connect the power adapter to the power grid and to the device.
- If the Ethernet connection is OK, the **LINK (yellow)** light should come on a moment later. The **ACTIVITY light (green)** indicates Ethernet activity.
- The **LINK (yellow)** flashing rapidly to indicate communication with the DHCP server.

2) The setting of the IP address - HWg-Config

The **HWg-Config** program for MS Windows can be downloaded at <https://www.hw-group.com> -> [Products](#) -> [Software](#) -> [HWg-Config](#).

- Launch **HWg-Config**, program automatically searches for LAN connected devices.
- If the device is connected later, click the **Find Devices** button. Local network devices will be listed. Click on the MAC address of the device to open the dialogue window for device settings.

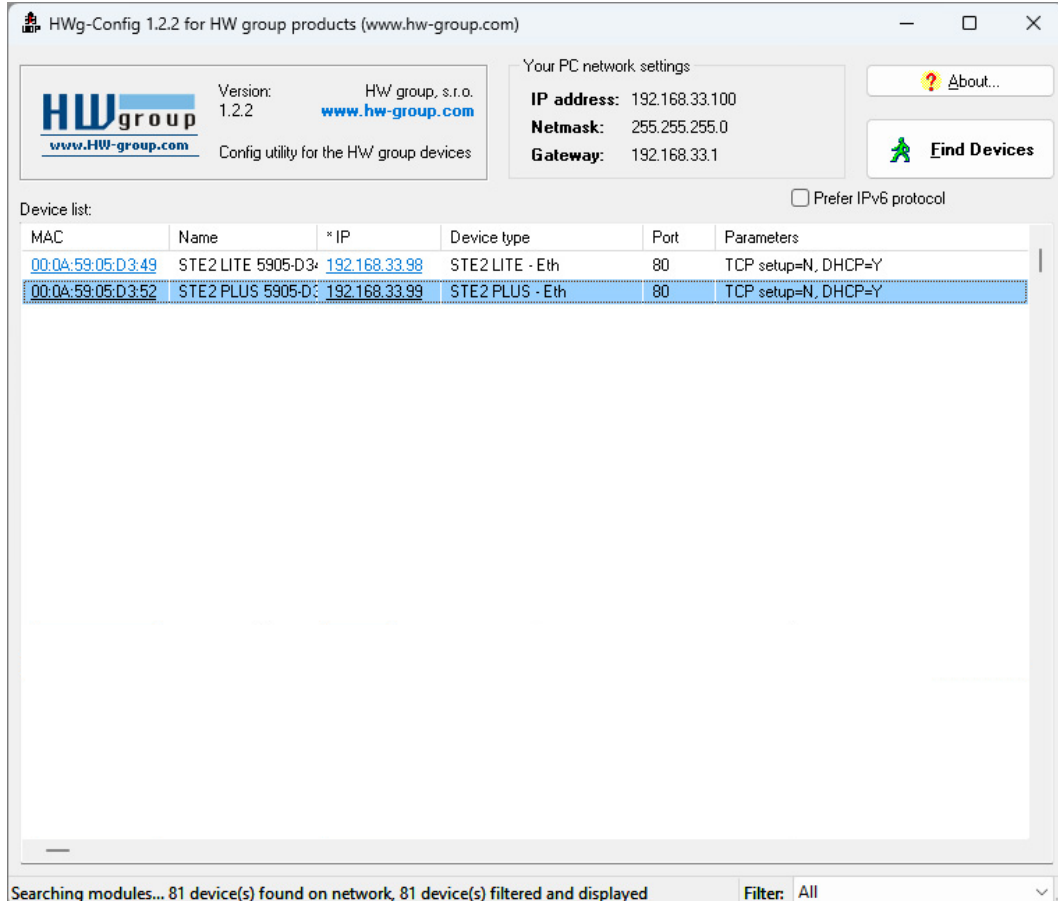

Set device network parameters:

- IP address / HTTP port (80 by standard)
- Your network mask
- IP address of your network gateway
- Device name (optional parameter)

Save the settings by clicking on **Apply Changes**.

The screenshot shows a 'Details' configuration window for the STE2 PLUS device. The window contains the following fields and controls:

- Name:** STE2 PLUS 5905-D352
- IP address:** 192.168.33.99 (DHCP)
- Port:** 80
- Open in WEB browser:** Button with a globe icon.
- Enable DHCP:** Checked checkbox.
- IPv6:**
 - Link local address: Not supported
 - Address/prefix: Not supported
- Mask:** 255.255.255.0 (DHCP)
- Gateway:** 192.168.33.1 (DHCP)
- MAC:** 00:0A:59:05:D3:52
- FW version:** 1.5.2
- Device type:** STE2 PLUS - Eth (101)
- DHCP:** Supported
- Enable IP access filter:** Unchecked checkbox.
- IP filter value:** 0.0.0.0
- IP filter mask:** 0.0.0.0
- Default values:**
 - Load defaults:** Button with a pencil icon.
- Enable NVT:** Unchecked checkbox.
- Enable TCP setup:** Unchecked checkbox, with an **Open** button.
- Enable TEA authorisation:** Unchecked checkbox.
- Check if new IP address is empty:** Checked checkbox.
- Cancel:** Button with a red X icon.
- Apply changes:** Button with a green refresh icon.

The status bar at the bottom left of the window shows 'Ready'.

Note: The device provides 2 options how to restore its default settings:

- 1) Right-click on the device's MAC address. Click to **Load default values** item.
Note: Device default values can be restored from the HWg-Config program only during first 60 settings after device powered up.
- 2) Switch off the device. Press the **RESET** button on the device, **hold it down and connect the device** power source (power adaptor). Hold the button down for another 5 seconds until all the LEDs light up.

3) How to open the device website

- 1) Enter the device IP address in your web browser if you know it.
- 2) Use right-click on device in the HWg-Config program. Select **Open in WEB Browser**.
- 3) Click on the underlined IP address in the HWg-Config program.

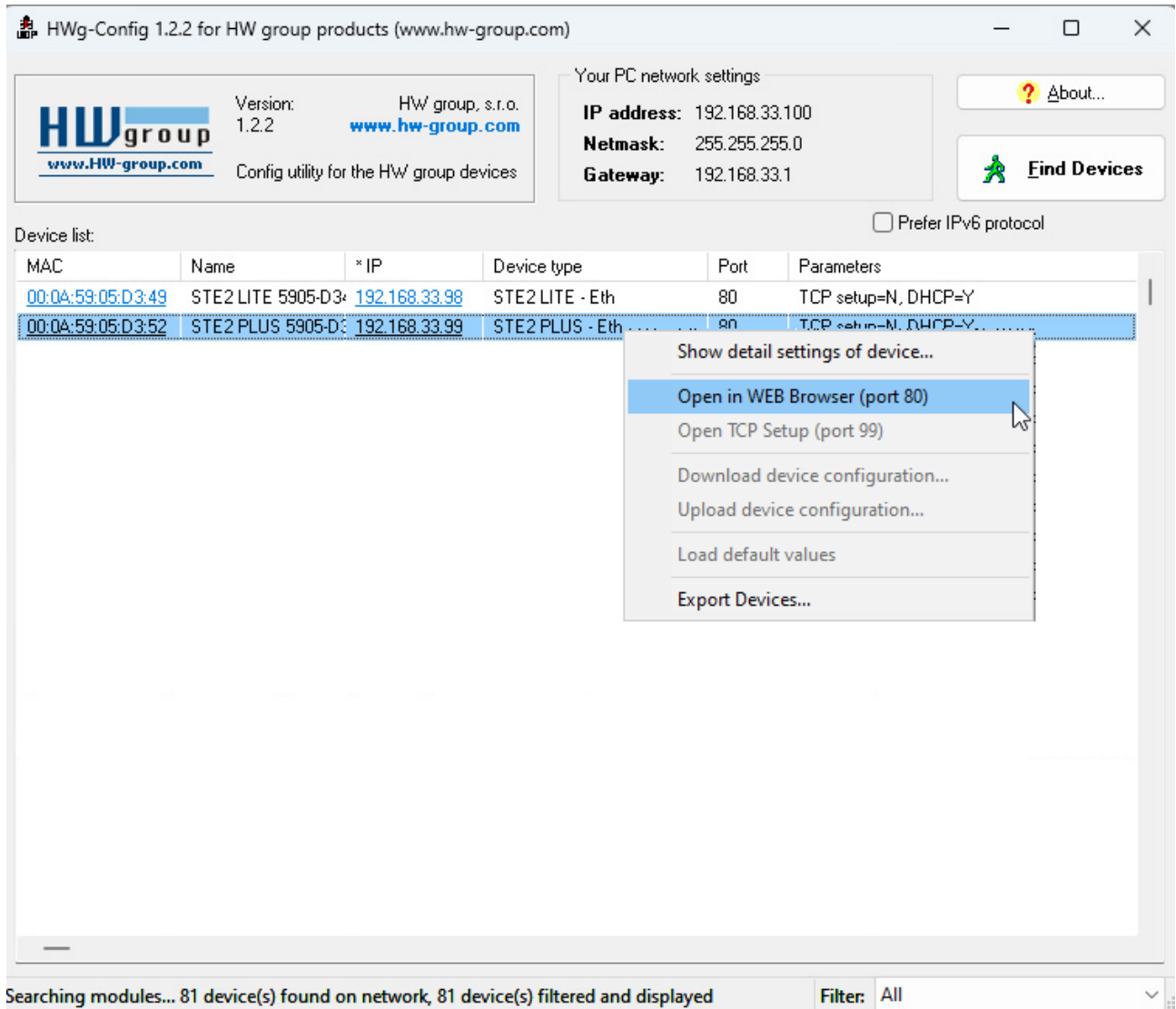

WWW interface

Home tab

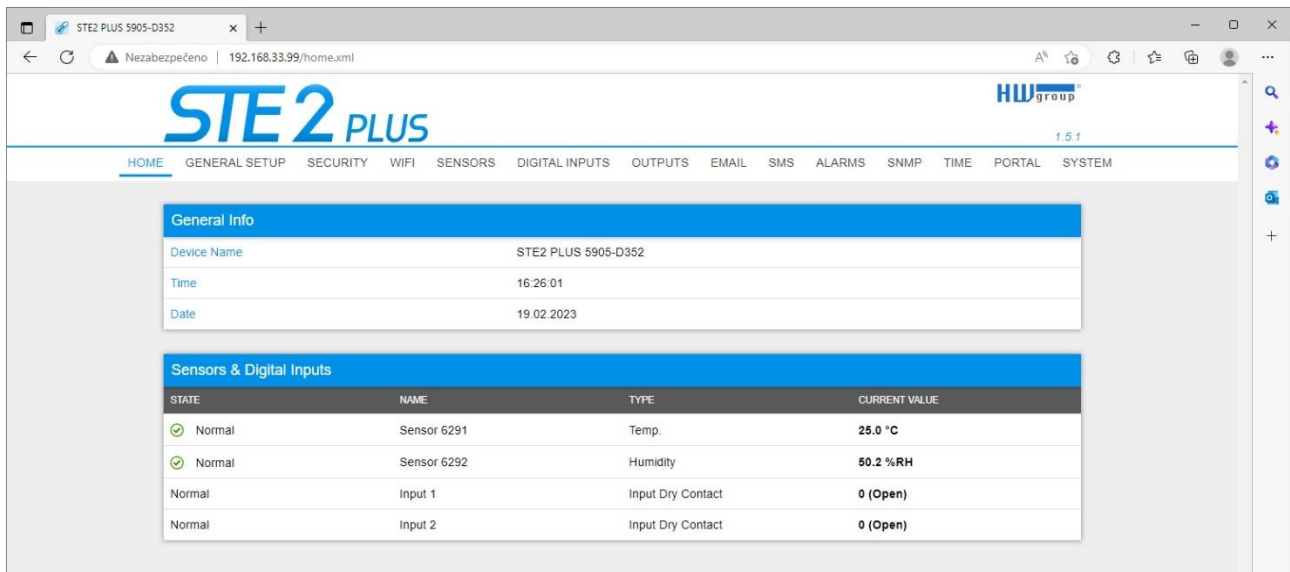

General Info section

- **Device Name:** This setting allows you to assign a unique name to the device, which can be helpful when managing larger installations. You can configure the device name on the General Setup tab.
- **Time:** Displays the current time of the device. You can set it manually on the Time tab, or you can choose to synchronize it automatically over the Internet. If the automatic synchronization is successful, the displayed time indicates that the device has Internet access.
- **Date:** Shows the current date of the device. You can set it manually on the Time tab, or you can synchronize it automatically over the Internet. If the automatic synchronization is successful, the displayed date indicates that the device has Internet access.

Sensors & Digital Inputs section

- **State** – Current state of the input or sensor.
 - **Normal** - Quiet state, everything is fine.
 - **Alarm High** - The value has exceeded the upper allowable limit.
 - **Alarm Low** - The value has dropped below the lower allowable limit.
 - **Alarm** - Binary input in Alarm state (as set by the Alarm Alert item on the Digital Inputs page).
- **Name** - The name of the sensor used for better identification in larger systems. The name can be set on the Sensors or Digital Input page.
- **Type** - Sensor Type; determines what type of sensor it is (temperature/humidity/digital input, etc.).
- **Current Value** - The current value including measured quantity.

General Setup tab

STE2 PLUS

1.5.2

HOME GENERAL SETUP SECURITY WIFI SENSORS DIGITAL INPUTS OUTPUTS EMAIL SMS ALARMS SNMP TIME PORTAL SYSTEM

General		
NAME	VALUE	DESCRIPTION
Device Name	<input type="text" value="STE2 PLUS 5905-D352"/>	0 to 32 characters
WWW Info Text:	<input a>"="" http:="" type="text" value="STE2 PLUS: For more information visit www.hw-group.com<=""/>	
Temperature unit	<input type="text" value="Celsius"/>	Celsius/Fahrenheit/Kelvin
WWW Update period:	<input type="text" value="1"/>	[s] Automatic update period in seconds. 0=> disabled
Periodic restart	<input type="text" value="Off"/>	Periodic restart time
Periodic status	<input type="text" value="0"/>	[H] Status info period in hours. 0=> disabled
Periodic status target	<input type="text" value="None"/>	
HTTP Port	<input type="text" value="80"/>	Default 80
HTTPS Port	<input type="text" value="443"/>	Default 443. See https settings at Security page
LED disable	<input type="checkbox"/>	Disable device LEDs (not in Ethernet RJ-45 connector)

Network IPv4		
NAME	VALUE	DESCRIPTION
DHCP	<input checked="" type="checkbox"/>	DHCP Enable/Disable
IP Address	<input type="text" value="192.168.33.99"/>	A.B.C.D
Network Mask	<input type="text" value="255.255.255.0"/>	A.B.C.D
Gateway	<input type="text" value="192.168.33.1"/>	A.B.C.D
DNS Primary	<input type="text" value="192.168.33.1"/>	A.B.C.D
DNS Secondary	<input type="text" value="192.168.100.237"/>	A.B.C.D

Network IPv6		
NAME	VALUE	DESCRIPTION
Enable	<input checked="" type="checkbox"/>	IPv6 Enable/Disable
SLAAC	<input checked="" type="checkbox"/>	SLAAC Enable/Disable
Link Local Address	<input type="text" value="fe80::20a:59ff:fe05:d352"/>	
Global Address	<input type="text" value="2a01:9422:105:100:20a:59ff:fe05:d352"/>	
Global Address Prefix	<input type="text" value="64"/>	
Gateway	<input type="text" value="fe80::ce2d:e0ff:fe03:bf4e"/>	
DNS Primary	<input type="text" value="2a01:9420:1::1"/>	
DNS Secondary	<input type="text" value="2a01:9420:4::1"/>	

Device Admin		
NAME	VALUE	DESCRIPTION
Username	<input type="text"/>	Admin username/password for device configuration changes [0 to 16 characters]
Password	<input type="text"/>	

General part

- **Device Name** - The device name (default "STE2 PLUS %Dev Hash%") helps to differentiate individual devices in the network.
- **WWW Info Text** - Text displayed in the footer of the device's web page.
- **Temperature Unit** - Allows selecting the unit to display temperature - Celsius, Fahrenheit or Kelvin. The Safe Range values are automatically calculated based on this option.
- **Periodic Restart** - A feature that enables periodic automatic restart of the device to improve its stability in exposed networks.
- **Periodic Status** - Allows periodic reporting of values and status of individual sensors and inputs via email or SMS (via SMS GW device). Think of it as a Heartbeat function to verify device functionality. The period is set in whole hours and a value of 0 disables the function. The target addresses for periodic status messages should be defined on the Alarms page.
- **Periodic Status Target** - Assigns to whom periodic status messages will be sent, with predefined addresses on the Alarms page.
- **Disable LEDs** - Allows disabling certain signaling LEDs on the device, except for those on the RJ45 connector.
- **HTTP Port** - The port number on which the embedded WWW server listens, which can be changed for accessing multiple devices from an external network through a router. The default port is 80, and setting the value to 0 disables HTTP support.
- **HTTPS Port** - The port number on which the embedded WWW server listens for secure HTTPS connections, which can be changed for accessing multiple devices from an external network through a router. The default port is 443 and setting the value to 0 disables HTTPS support. It's essential to verify any changes with the network administrator.

Network IPv4 section

The IPv4 parameters of the RJ45 connection. WiFi parameters connection are in the WiFi tab.

- **DHCP** - Enables the IP address setting function of the DHCP server, if available. Enabling or disabling DHCP depends on the needs of the user and the network administrator.
- **IP Address** - The IP address of the device, assigned by the network administrator.
- **Network Mask** - Network mask, assigned by the network administrator.
- **Gateway** - IP address of the default gateway, assigned by the network administrator.
- **DNS Primary / DNS Secondary** - IP address of the DNS server, assigned by the network administrator.

Network IPv6

The IPv6 parameters of the RJ45 connection. WiFi parameters connection are in the WiFi tab.

- **Enable** - Turns IPv6 support on and off.
- **SLAAC** - Enables and disables Stateless Address Auto-configuration (SLAAC) support. SLAAC is the most common method of auto-configuring devices on IPv6 networks that do not require DHCPv6.
- **Link-Local Address** - IPv6 device address derived from the physical (MAC) address.
- **Global Address** - A global IPv6 address consisting of a physical address and a prefix.
- **Global Address Prefix** - The size of the IPv6 network prefix (default 64).
- **Gateway** - The IP address of the default gateway, assigned by SLAAC or the network administrator.
- **DNS Primary / DNS Secondary** - IP address of the DNS server, assigned by SLAAC or assigned by the network administrator.

Device Admin section

- **Username / Password** - The username and password used to secure access to the web device environment.

Security tab

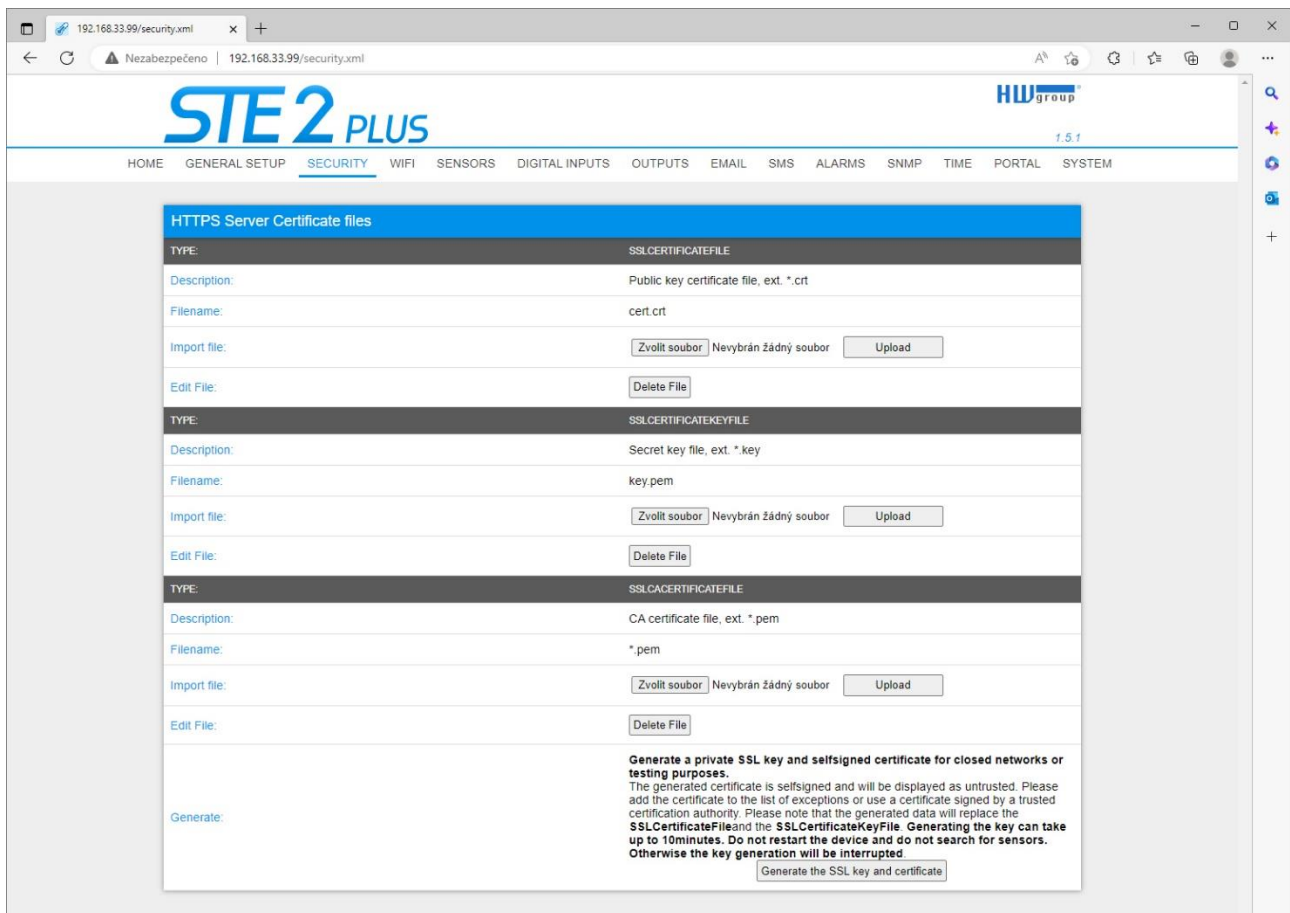

HTTPS Server Certificate files

Manages certificates required for the HTTPS server. Allows you to upload or delete a public key, a private key, or a certificate from the certificate authority (CA) that issued the public key certificate.

Generate the SSL key and certificate

Generate a private SSL key and self-signed certificate for closed networks or testing purposes. The generated certificate is self-signed and will be displayed as untrusted.

Please add the certificate to the list of exceptions or use a certificate signed by a trusted certificate authority. Please note that the generated data will replace the SSL Certificate File and the SSL Certificate Key File.

Generating the key may take several minutes. Do not restart the device and do not search for sensors. Otherwise, the key generation will be interrupted.

WiFi tab

When WiFi is off, only the Enable option is displayed:

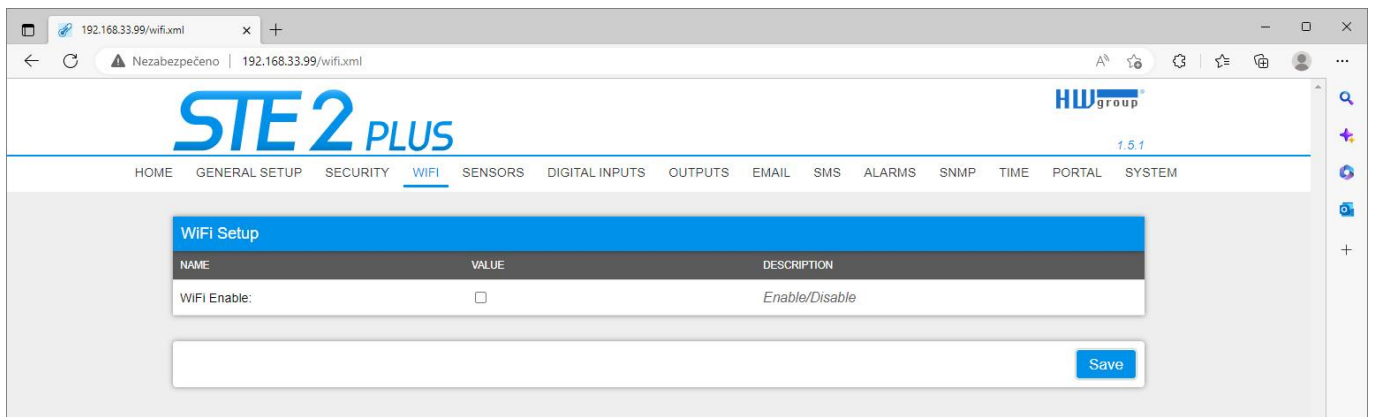

All options are available after enabling:

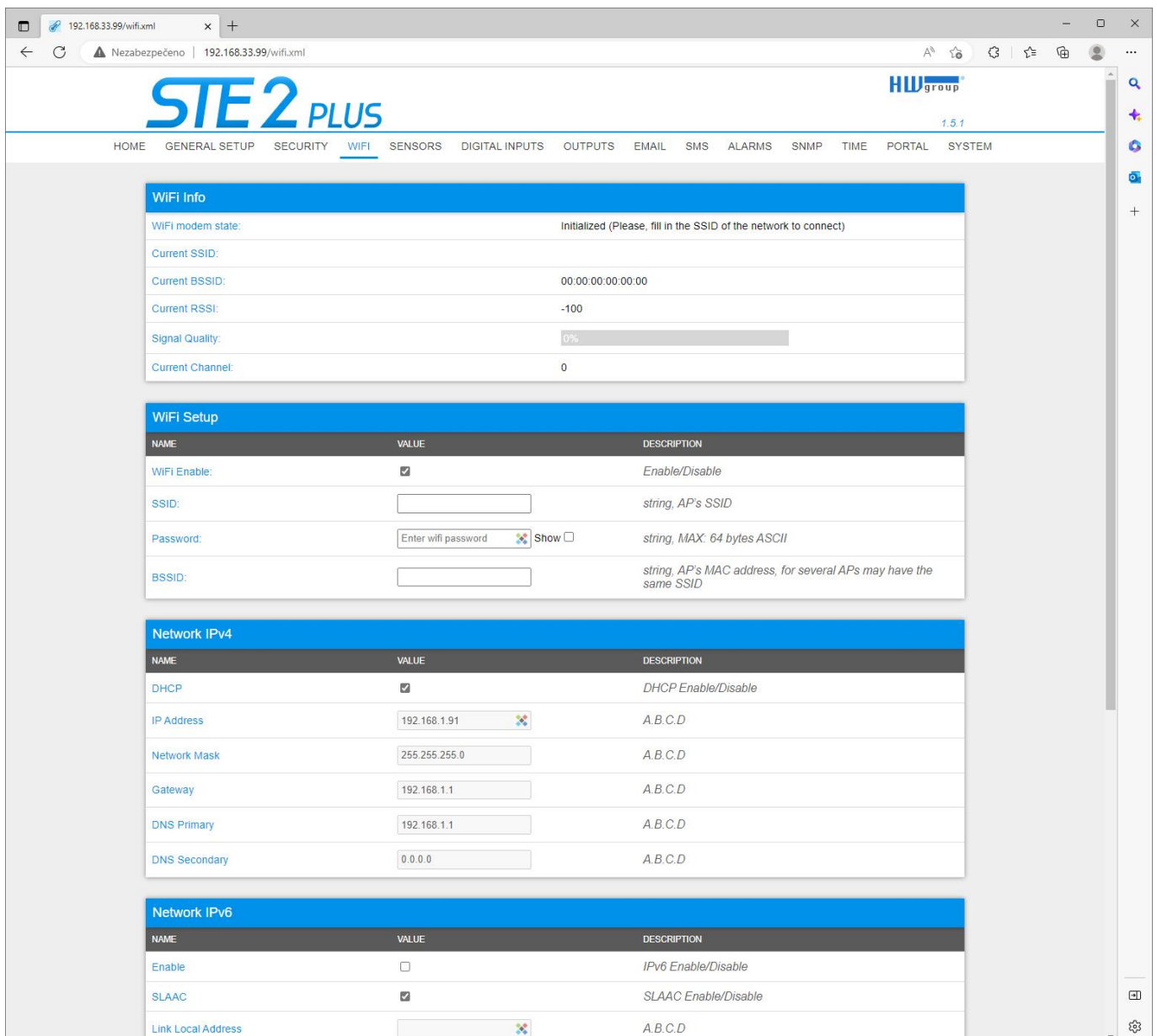

WiFi Info section

- **WiFi modem state**
 - **Disable** - Wifi is disabled.
 - **Wait for power on** - Waits for WiFi module when power on.
 - **Init** - Initializing of WiFi module.
 - **Connecting** - Connecting.
 - **SSID check** - SSID check.
 - **Connected** - Connected to selected WiFi network.
 - **Network WiFi scan** - Scan of available WiFi networks.
 - **Wait for scan** - Waits for Network WiFi scan.
- **Current SSID** - Current name of the network the device is connected to. If the parameter is missing, the device is not connected to any WiFi network.
- **Current BSSID** - Current identifier of the WiFi network connection point. If the parameter is missing, the device is not connected to any WiFi network.
- **Current RSSI** - Relative strength of signal input. The lower the RSSI, the stronger the signal.
- **Signal Quality** - Strength of WiFi signal in % with graphic indicator.
- **Current Channel** - WiFi channel on which the device communicates. If the parameter is missing, the device is not connected to any WiFi network.

WiFi Setup section

- **WiFi Enable** - Enable or disable WiFi. By default, the wireless interface is disabled. Device restart follows enabling.
- **SSID** - The name of the WiFi network to which you want the device to connect. If you do not know your network name, use the Scan AP function at the bottom of the page.
- **Password** - Secured network password. If you do not know it, contact your network administrator.
- **BSSID** - Identifier of the WiFi network connection point (MAC address of the connection point). Optional data.

Network IPv4 section

WiFi network parameters. Only the wireless interface is set here. Configure RJ45 LAN parameters in the General Setup tab.

- **DHCP** - Enables the IP address setting function of the DHCP server, if available. Enabling or disabling DHCP depends on the needs of the user and the network administrator.
- **IP Address** - The IP address of the device, assigned by the network administrator.
- **Network Mask** - Network mask, assigned by the network administrator.

- **Gateway** - The IP address of the default gateway, assigned by the network administrator.
- **DNS Primary / DNS Secondary** - IP address of the DNS server, assigned by the network administrator.

Network IPv6

WiFi network parameters. Only the wireless interface is set here. Configure RJ45 LAN parameters in the General Setup tab.

- **Enable** - Turns IPv6 support on and off.
- **SLAAC** - Enables and disables Stateless Address Auto-configuration (SLAAC) support. SLAAC is the most common way to auto-configure devices on IPv6 networks that do not require DHCPv6.
- **Link-Local Address** - IPv6 device address derived from the physical (MAC) address.
- **Global Address** - A global IPv6 address consisting of a physical address and a prefix.
- **Global Address Prefix** - The size of the IPv6 network prefix (64 by default).
- **Gateway** - The IP address of the default gateway, assigned by SLAAC or the network administrator.
- **DNS Primary / DNS Secondary** - IP address of the DNS server, assigned by SLAAC or assigned by the network administrator.

Wifi Scan List section

- **SSID** - Name of the WiFi network found.
- **BSSID** - Connection point identifier (MAC address).
- **Channel** - The WiFi channel where the AP communicates.
- **Security** - The security type of WiFi communication.
- **Signal** - WiFi signal strength in % with graphical indicator.

Connecting to a discovered WiFi

- Click on the SSID of the discovered network to pre-fill the WiFi settings and then just fill in the Password. The BSSID field will remain blank. Standard settings. When you change the AP, it will reconnect itself.
- Clicking on the BSSID will pre-fill not only the network name (SSID) but also the MAC address of the specific AP (BSSID). The device will connect to that AP and in the case of pooled networks will not try to reconnect.

Scan AP (WiFi Access Points)

Wifi Scan List				
SSID	BSSID	CHANNEL	SECURITY	SIGNAL
Poseidon	78:45:58:D5:FA:54	1	WPA2 PSK	92%
PosDam	7A:45:58:A5:FA:54	1	OPEN	90%
HWghost	7A:45:58:95:FA:54	1	WPA2 PSK	90%
HumaiSmart_40F5204AC2F4	40:F5:20:4A:C2:F5	1	OPEN	60%
HWghost	02:EC:DA:3E:38:12	6	WPA2 PSK	54%
Poseidon	FC:EC:DA:3E:38:12	6	WPA2 PSK	52%
PosDam	06:EC:DA:3E:38:12	6	OPEN	52%
HumaiSmart_C45BBE37D034	C4:5B:BE:37:D0:35	1	OPEN	48%
Poseidon	FC:EC:DA:3E:39:E6	11	WPA2 PSK	44%
HWghost	02:EC:DA:3E:39:E6	11	WPA2 PSK	44%
Poseidon	FC:EC:DA:3B:ED:55	6	WPA2 PSK	42%
PosDam	06:EC:DA:3B:ED:55	6	OPEN	42%
PosDam	06:EC:DA:3E:39:E6	11	OPEN	42%
DIRECT-dc-HP M209 LaserJet	52:C2:E8:C6:22:DC	6	WPA2 PSK	40%
HWghost	02:EC:DA:3B:ED:55	6	WPA2 PSK	40%
Testovna	00:04:56:A0:94:D0	11	WPA2 PSK	30%

WiFi debug section

- Provides useful info for debugging WiFi connection

Sensors tab

STATE	ID	TYPE	NAME	CURRENT VALUE	SAFE RANGE		HYSTERESIS	ALARM TRIGGER DELAY [S]	ALARM TARGET	VIRTUAL OUTPUTS	SENSOR SERIAL CODE
					LOW	HIGH					
🟢	6291	Temp.	Sensor 6291	25.0 °C	10.0	60.0	1.0	0	None	None	28931800590a00a6
🟢	6292	Humidity	Sensor 6292	50.2 %RH	30.0	80.0	10.0	0	None	None	26941800590a005c

Sensor List section



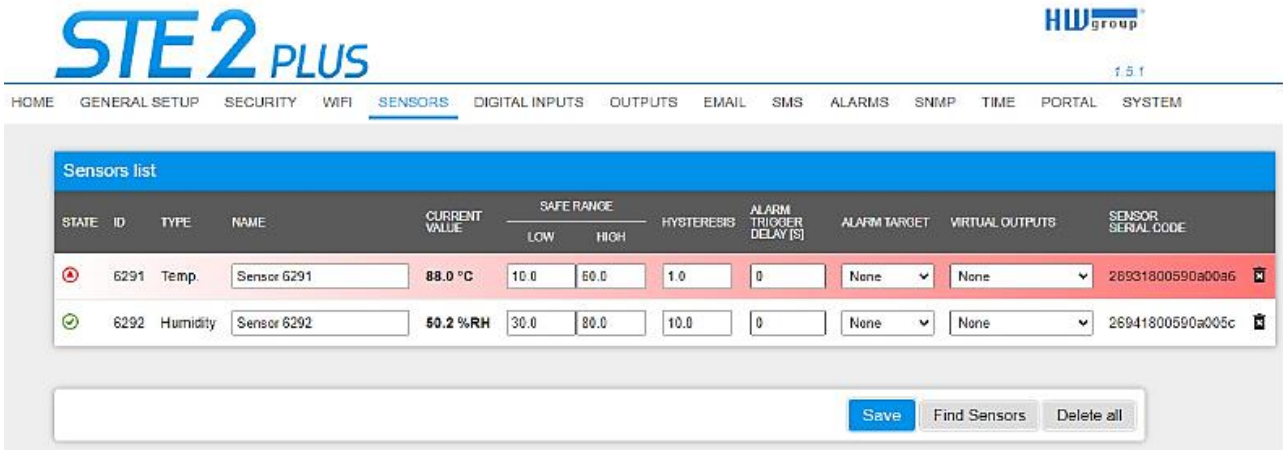

- **State** - State of the DI (input) or sensor.
 - 🟢 **Normal** - Quiet state, everything is fine.
 - 🚨 **Alarm High** - The value has exceeded the upper allowable limit.
 - 🚨 **Alarm Low** - The value has fallen below the lower allowable limit.
- **ID** - 2 bytes sensor ID (identical to ID on Poseidon2 devices).
- **Type** - Sensor type; indicates what type of sensor it is (temperature/humidity etc.).
- **Name** - The name of the sensor, used for better identification in larger systems. It can be set on the Sensor or Digital Input tab.
- **Current Value** - The current value including the measured quantity.
- **Safe Range** - Refers to the range of acceptable (allowed) values that are considered within normal limits. If the current value falls outside the Safe Range, an alarm is triggered to indicate that the measurement is out of bounds and requires attention.
- **Hysteresis** - The parameter specifies a range of insensitivity when the measured value crosses the limit value. It prevents triggering of multiple alarms when the value oscillates around the limit. For more details, please refer to page 40 of the manual.
- **Alarm Target** - Allows you to define targets where Alarm messages (SMS + Email) will be sent. Target destinations are set on the Alarms page. The drop-down menu allows you to assign an existing set of targets to the sensor or create a new one.
- **Alarm Trigger Delay [s]** - Delays the sending of alarm start information by a defined time.
- **Virtual Outputs** - Allows you to configure a remote digital output on either a Poseidon2 or Damocles2 device to be switched On/Off based on the start or end of an alarm. You can set the Virtual Outputs parameters and their corresponding address on the Outputs page.
- **Sensor Serial Code** - The full ID of the 1-Wire sensor.

-  **Delete** – The button to delete a specific sensor.

Sensor alarm state indication*



The screenshot shows the STE2 PLUS web interface with the 'SENSORS' tab selected. The 'Sensors list' table contains two entries:

STATE	ID	TYPE	NAME	CURRENT VALUE	SAFE RANGE		HYSTERESIS	ALARM TRIGGER DELAY [S]	ALARM TARGET	VIRTUAL OUTPUTS	SENSOR SERIAL CODE
					LOW	HIGH					
	6291	Temp	Sensor 6291	88.0 °C	10.0	60.0	1.0	0	None	None	26931800590a00a6 
	6292	Humidity	Sensor 6292	50.2 %RH	30.0	80.0	10.0	0	None	None	26941800590a005c 

At the bottom of the table, there are three buttons: 'Save', 'Find Sensors', and 'Delete all'.

* Sensor in the Alarm state is highlighted.

Hysteresis

The Hysteresis value defines the width of the tolerance range for sending an alarm. This function stops multiple alarms from happening when the value goes up and down around a set point. You can see this on the graph.

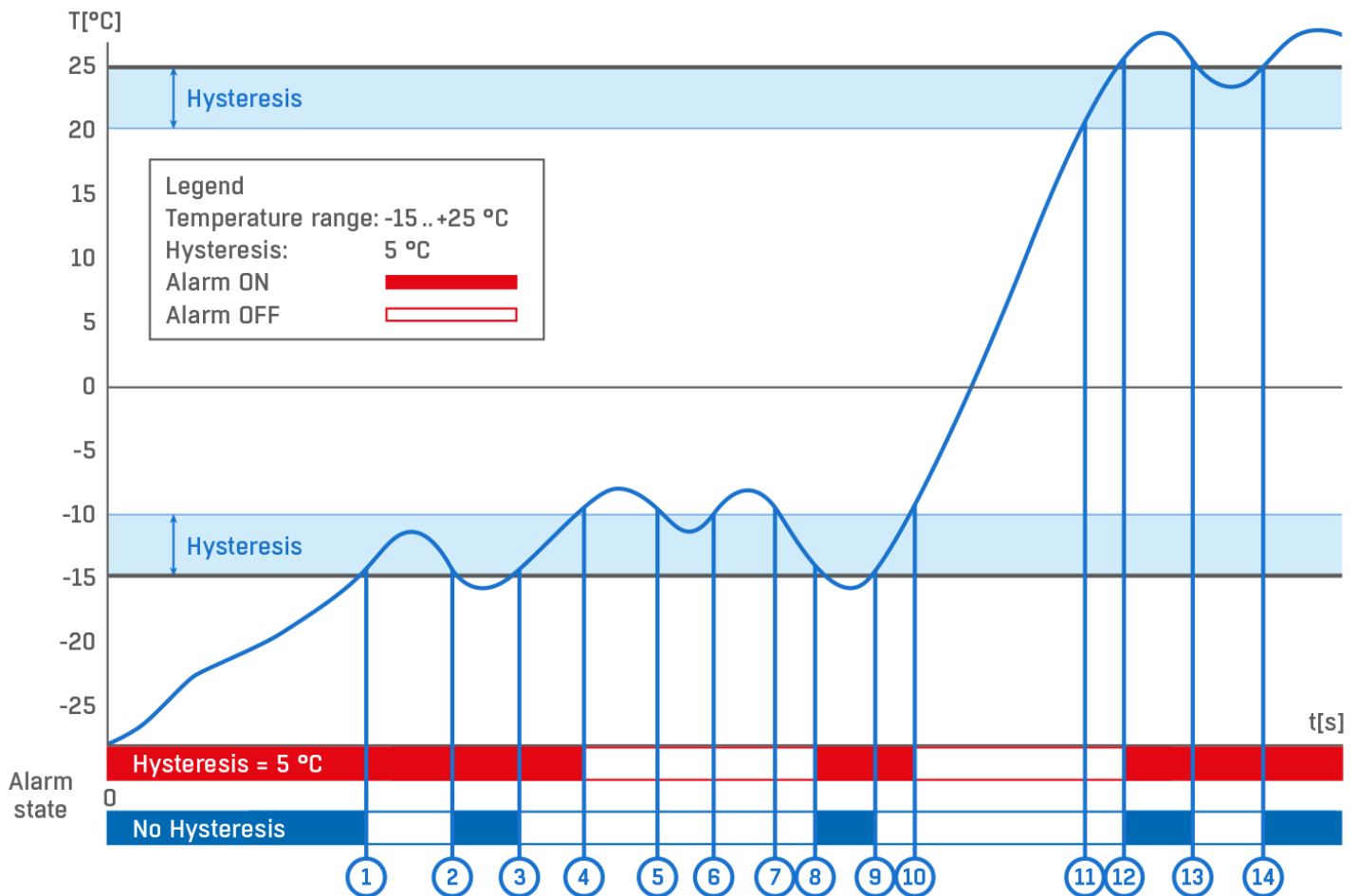

Within the internal 5°C hysteresis band, the alarm would be activated at **point 8** and would end at **point 9**. Because of the hysteresis function, the alarm is extended until the temperature reaches the end of the hysteresis zone (point 10) $5\text{ °C} + (-15\text{ °C}) = -10\text{ °C}$.

- **Hysteresis (=5 °C):** The unit sends **3** alerts (email, SMS, ...) Alarm at points **0-4, 8-10, 12** and upwards.
- **Without hysteresis (0 °C):** The unit sends **8** alerts (email, SMS, ...) Alarm at points **0-1, 2-3, 8-9, 12-13, 14** and upwards.

Digital Inputs tab

ID	CURRENT STATE	NAME	STATE NAME		ALARM ALERT	ALARM TRIGGER DELAY [s]	ALARM TARGET	VIRTUAL OUTPUTS
			LOG 0	LOG 1				
1	0 (OK)	Input 1	OK	Flooded	1 (Active if Close)	0	Default 1	Virtual Output 1151
2	0 (Open)	Input 2	Open	Closed	Disabled	0	None	None

Digital Inputs List* section

- **ID** - Identification of the input within the device.
- **Current State** - List the current state of the input (0/1 and the state name).
- **Name** - Name of the input max. 22 characters (e.g. "2p door left", "smoke section 1").
- **Alarm Alert** - Alarm status definition for each input.
- **Alarm Target** - Allows you to define targets where Alarm messages will be sent (SMS + Email). Target destinations are set on the Alarms page. The drop-down menu allows you to assign an existing set of targets to the sensor or create a new one.
- **Active if Close** - Alarm active when the input is in state 1 (On).
- **Active if Open** - Alarm active when the input is in state 0 (Off).
- **Disabled** - The input does not have a defined Alarm state.
- **Alarm Trigger Delay [s]** - Delays the sending of alarm start information by a defined time.
- **Virtual Outputs** - Allows you to configure a remote Digital Output on either a Poseidon2 or Damocles2 device to be switched On/Off based on the start or end of an alarm. You can set the Virtual Outputs parameters and their corresponding address on the Outputs page.

* DI input in the Alarm state is highlighted.

Outputs tab

Digital Outputs are not physically connected on the STE2 PLUS device. It supports only VDO (Virtual Digital Outputs) as DO on remote devices connected to the same LAN.

STE2 PLUS

1.5.2



HOME GENERAL SETUP SECURITY WIFI SENSORS DIGITAL INPUTS **OUTPUTS** EMAIL SMS ALARMS SNMP TIME PORTAL SYSTEM

Virtual Output List									
ENABLED	NAME	VALUE	TARGET ADDRESS	PORT	REMOTE ID	AUTHENTICATION		TEST	
<input type="checkbox"/>	Virtual Output 1151	0(OFF)	<input type="text"/>	80	0	<input type="text" value="Username"/>	<input type="text" value="Password"/>	<input type="button" value="Test on"/>	<input type="button" value="Test off"/>
<input type="checkbox"/>	Virtual Output 1152	0(OFF)	<input type="text"/>	80	0	<input type="text" value="Username"/>	<input type="text" value="Password"/>	<input type="button" value="Test on"/>	<input type="button" value="Test off"/>
<input type="checkbox"/>	Virtual Output 1153	0(OFF)	<input type="text"/>	80	0	<input type="text" value="Username"/>	<input type="text" value="Password"/>	<input type="button" value="Test on"/>	<input type="button" value="Test off"/>
<input type="checkbox"/>	Virtual Output 1154	0(OFF)	<input type="text"/>	80	0	<input type="text" value="Username"/>	<input type="text" value="Password"/>	<input type="button" value="Test on"/>	<input type="button" value="Test off"/>
<input type="checkbox"/>	Virtual Output 1155	0(OFF)	<input type="text"/>	80	0	<input type="text" value="Username"/>	<input type="text" value="Password"/>	<input type="button" value="Test on"/>	<input type="button" value="Test off"/>
<input type="checkbox"/>	Virtual Output 1156	0(OFF)	<input type="text"/>	80	0	<input type="text" value="Username"/>	<input type="text" value="Password"/>	<input type="button" value="Test on"/>	<input type="button" value="Test off"/>
<input type="checkbox"/>	Virtual Output 1157	0(OFF)	<input type="text"/>	80	0	<input type="text" value="Username"/>	<input type="text" value="Password"/>	<input type="button" value="Test on"/>	<input type="button" value="Test off"/>
<input type="checkbox"/>	Virtual Output 1158	0(OFF)	<input type="text"/>	80	0	<input type="text" value="Username"/>	<input type="text" value="Password"/>	<input type="button" value="Test on"/>	<input type="button" value="Test off"/>

Virtual outputs allow the usage of physical outputs on Poseidon2 or Damocles2 units (Box2Box). VDO (Virtual Digital Outputs) are defined with period (every 60 s).

- **Enabled** - enables the virtual output functions.
- **Name** - name of the output, up to 12 chars (e.g. "top fan", "Door rack 4").
- **Value** - actual status of output.
- **Target address** (Remote device address) - IP address of the remote side where the output is controlled.
- **Port** - TCP port where the remote side listens.
- **Remote ID** - unique ID of the output within the device [151 ..158]. Corresponds to the ID at the Outputs tab at the remote side.
- **Username/Password** - fill it in if the remote side uses authorization.
- **Test on / off** - simple way to test configured VDO.

Email tab



1.5.1

HOME GENERAL SETUP SECURITY WIFI SENSORS DIGITAL INPUTS OUTPUTS **EMAIL** SMS ALARMS SNMP TIME PORTAL SYSTEM

Email Settings

NAME	VALUE	DESCRIPTION
SMTP Server	<input type="text" value="some smtp server"/>	IP Address or DNS Name
SMTP Port	<input type="text" value="25"/>	Default 25
Authentication	<input type="checkbox"/>	Enable/Disable
Secure TLS mode	<input type="checkbox"/>	Enable/Disable
Use HTML formatting	<input type="checkbox"/>	Uses html to format email message body.
Username	<input type="text"/>	0 to 128 characters
Password	<input type="password"/>	0 to 128 characters
Importance	<input type="text" value="Normal"/>	Email importance flag
From	<input type="text" value="user@domain.com"/>	Device email address
Subject	<input type="text" value="subject"/>	Beginning of email subject

[Save](#)

Email Test Log

Email address

Email for testing

[Test Email](#)

Email Settings

- **SMTP Server** - The IP address or domain address of the SMTP server.
Note: Consider the long-term stability of the used SMTP server. If the service provider change security requirements (separated username or password for example) your device alerting functionality will be lost without any warning. Consider using the Portal (SensDesk Technology) alerting services.
- **SMTP Port** - Port number on which the email server tunes in – 25 by default.
- **Authentication** - Enable authentication; check if the SMTP server requires authentication.
- **Secure TLS mode** - Check if the SMTP server requires secure communication via SSL/TLS.
- **Username** - Username for the SMTP server authentication. If the Authentication field is not checked, the content of this field is irrelevant.
- **Password** - Password for SMTP server authentication. If the Authentication field is not checked, the content of this field is irrelevant.
- **Importance** - Sets the priority of the email message. Important for filtering and further processing alarm messages.

- **From** - Sender's email address, i.e. of the device. The address may be required by the SMTP servers and can be used to identify the device or to filter and further process alarm messages.
- **Subject of email** - The field content can be used to identify the device or for filtering and further processing of alarm messages.

Email Test Log section

In this section, the SMTP server settings can be tested. Click Test Email to send a test email to the specified Email address. The Debug log window shows the communication with the SMTP server.

SMS tab

This functionality requires HWg-SMS device with active SIM card registered in the network.

Remote SMS gateway

NAME	VALUE	DESCRIPTION
Enable	<input type="checkbox"/>	Enable/Disable
SMS Gateway Address	<input type="text"/>	IP Address or DNS Name
Port	80	Default 80
Username	<input type="text"/>	
Password	<input type="text"/>	

SMS Test Log

Phone number: Phone number for testing

Debug log window.

Test SMS Test Call

Remote SMS gateway

- **Enable** - Turns on the SMS sending function. For sending alert, the SMS alarm action must be configured at the sensor or DI settings.
- **SMS Gateway Address** - IP address where SMS-GW device is located. It can be set including service - typically /service.xml (for example "<http://192.168.15.1/service.xml>")
- **Port** - The TCP port on which the gateway listens.
- **Username** - User name for authorization in SMS GW.
- **Password** - Password for authorization in SMS GW.
- **SMS + Ring When Alarm** - Enables sending an SMS and then dialing the number.

SMS Test Log

In this section, the SMS gateway settings can be tested.

- **Test SMS** - Sends a test text message to the specified Phone number.
- **Test Call** - Dials the specified Phone number.
- **Debug log window** - Shows the communication with the SMS gateway.

Alarms tab

This tab is used to set alarm targets. Up to 3 sets of destinations can be created and each set can contain up to 5 email destinations and 5 phone number destinations for SMS and voice call alarms. STE2 PLUS support also SNMP Traps, so also up to 5 SNMP Traps (v1 or v3).

These sets are then assigned to individual sensors and Digital Inputs. The set is created either by pressing the + button on the Alarms page or by selecting **Add new...** on the Sensor or Digital Input edit page.

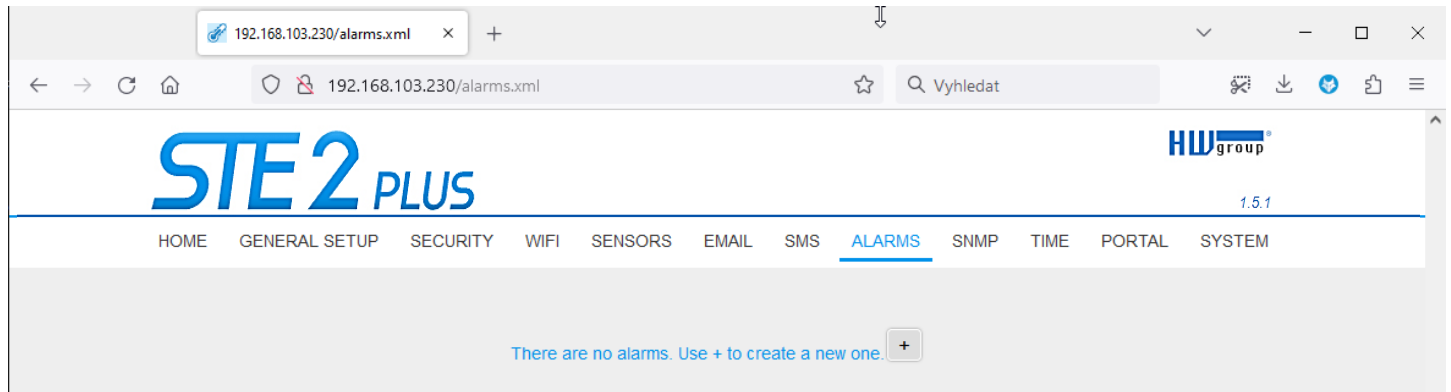

Alarm Target

A set of targets. The set can be named for clarity.

- **Email list** - A set of email addresses to which alarm messages will be sent. The SMTP server on the Email tab must be set up correctly for the email to be sent.
 - **Email address** - The field can only contain one email address at a time.
- **SMS list** - A set of phone numbers to which alarm messages will be sent. To send SMS, the SMS gateway must be set up correctly on the SMS tab.
 - **Phone number** - The field may only contain one phone number at a time.
 - **Call** - If checked, the phone number will ring after the SMS is sent (the user does not need to hear the incoming SMS). Ringing lasts for about 20 seconds for each individual number and then is terminated. Answering the call only ends the ringing, no voice message is sent.

Alarms Settings		
NAME	VALUE	DESCRIPTION
Alarms reminder period	<input type="text" value="5"/>	[Min] If any alarm lasts longer than this interval, the alarm message will be resend to specified target. Every X minutes.
Alarm reminder target	<input type="text" value="Default 1"/>	

Default 1 Default 2 +

Alarm Target: <input type="text" value="Default 1"/>		DELETE ✕					
EMAIL ADDRESS							
Email list	<input type="text" value="example@hwg.cz"/>						
	<input type="text" value="example@hwg.cz"/>						
	<input type="text" value="example@hwg.cz"/>						
	<input type="text" value="example@hwg.cz"/>						
	<input type="text" value="example@hwg.cz"/>						
PHONE NUMBER CALL							
SMS list	<input type="text" value="+420603603603"/>	<input type="checkbox"/>					
	<input type="text" value="+420603603603"/>	<input type="checkbox"/>					
	<input type="text" value="+420603603603"/>	<input type="checkbox"/>					
	<input type="text" value="+420603603603"/>	<input type="checkbox"/>					
	<input type="text" value="+420603603603"/>	<input type="checkbox"/>					
SNMP trap list							
IP ADDRESS	PORT	TRAP VERSION	COMMUNITY/USERNAME	AUTH TYPE	AUTH PASSWORD	PRIVACY TYPE	PRIVACY PASSWORD
<input type="text" value="192.168.0.100"/>	<input type="text" value="0"/>	<input type="text" value="V1"/>	<input type="text" value="Public"/>				
<input type="text" value="192.168.0.100"/>	<input type="text" value="0"/>	<input type="text" value="V1"/>	<input type="text" value="Public"/>				
<input type="text" value="192.168.0.100"/>	<input type="text" value="0"/>	<input type="text" value="V1"/>	<input type="text" value="Public"/>				
<input type="text" value="192.168.0.100"/>	<input type="text" value="0"/>	<input type="text" value="V1"/>	<input type="text" value="Public"/>				
<input type="text" value="192.168.0.100"/>	<input type="text" value="0"/>	<input type="text" value="V1"/>	<input type="text" value="Public"/>				
							<input type="button" value="Save"/>



SNMP trap list

- **IP address** - The destination address where SNMP Traps will be sent.
- **Port** - The destination port where SNMP Traps will be sent.
- **Trap version**
 - **Community/Username** - The text Community name for SNMPv1 or User name for SNMPv3.

- **Auth. Type** - The type of cypher used for user authentication. MD5 and SHA options are available (SNMPv3 only).
- **Auth. Password** - The password used to authenticate the user (SNMPv3 only).
- **Privacy Type** - The type of cypher used to secure communications. DES and AES options are available (SNMPv3 only).
- **Privacy Password** - The password (key) used to encrypt communication (SNMPv3 only).

SNMP tab

The SNMP tab configure parameters for Open API - SNMP protocol.



1.5.1

HOME
GENERAL SETUP
SECURITY
WIFI
SENSORS
DIGITAL INPUTS
OUTPUTS
EMAIL
SMS
ALARMS
SNMP
TIME
PORTAL
SYSTEM

SNMP Settings

NAME	VALUE	DESCRIPTION
System Name	<input type="text" value="STE2 PLUS 6906-D352"/>	0 to 32 characters
System Location	<input type="text"/>	0 to 32 characters
System Contact	<input type="text" value="STE2 PLUS"/>	
SNMP port	<input type="text" value="161"/>	Default port 161
SNMPv3 enable	<input checked="" type="checkbox"/>	

[Show OID keys table](#)

SNMPv1 Access

COMMUNITY	READ	WRITE	ENABLE
<input type="text" value="public"/>	<input checked="" type="checkbox"/>	<input type="checkbox"/>	<input checked="" type="checkbox"/>
<input type="text" value="private"/>	<input checked="" type="checkbox"/>	<input checked="" type="checkbox"/>	<input checked="" type="checkbox"/>

SNMPv3 Access

USERNAME	AUTH TYPE	AUTH PASSWORD	PRIVACY	PRIVACY PASSWORD	READ	WRITE	ENABLE
<input type="text"/>	None	<input type="text"/>	None	<input type="text"/>	<input checked="" type="checkbox"/>	<input type="checkbox"/>	<input type="checkbox"/>
<input type="text"/>	None	<input type="text"/>	None	<input type="text"/>	<input checked="" type="checkbox"/>	<input type="checkbox"/>	<input type="checkbox"/>

SNMP Settings section

- **System Name** - The name of the device within SNMP.
- **System Location** - The location of the device within SNMP.
- **System Contact** - Contact for the device administrator within SNMP.
- **SNMP Port** - The port number on which SNMP can communicate - 161 by default.
- **SNMPv3 Enable** - Enable the SNMPv3 function

SNMPv1 Access section

- **Community** - The name of the SNMP community for accessing the device over SNMPv1. 2 communities can be defined. For each Community you can define whether it has permissions for:
 - **Read** - Enables or disables the read function.
 - **Write** - Enables or disables the write function.
 - **Enable** - Enables or disables a specific community.

SNMPv3 Access section

Username and passwords for SNMPv3 communication.

- **User name** - User name.
- **Auth. Type** - The type of cypher used for user authentication (MD5 and SHA).
- **Auth. Password** - The password used to authenticate the user.
- **Privacy Type** - The type of cypher used to secure communications (DES and AES).
- **Privacy Password** - The password (key) used to encrypt the communication.
- **Read** - Enables or disables the read function.
- **Write** - Enables or disables the write function.
- **Enable** - Enables or disables a specific community.

Show OID keys table

This function lists the entire tree of variables with the full SNMP OID and explanations about the type variables. A MIB is also available for connecting devices to 3rd party monitoring systems.

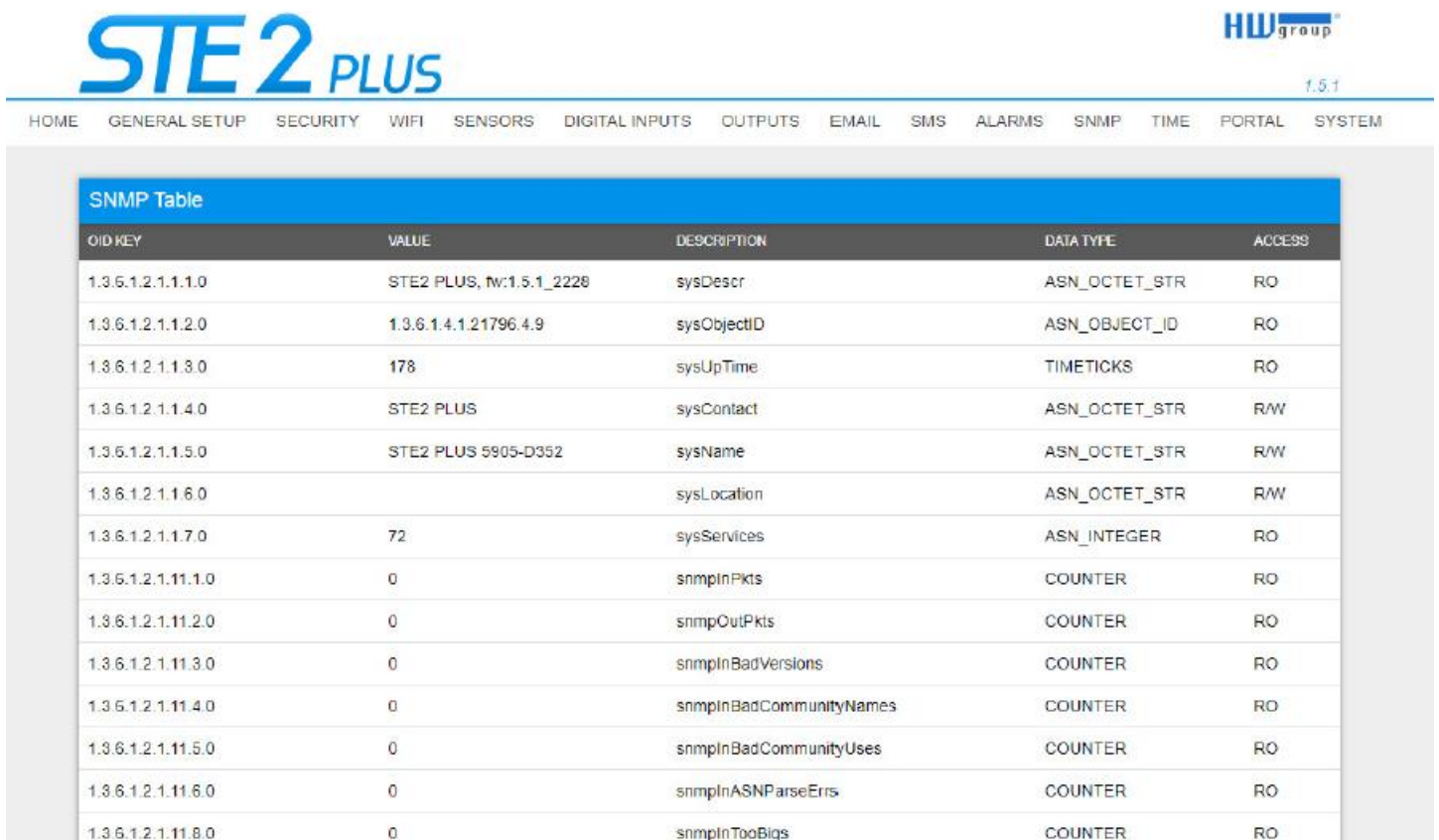

OID KEY	VALUE	DESCRIPTION	DATA TYPE	ACCESS
1.3.6.1.2.1.1.1.0	STE2 PLUS, fw:1.5.1_2228	sysDescr	ASN_OCTET_STR	RO
1.3.6.1.2.1.1.2.0	1.3.6.1.4.1.21796.4.9	sysObjectID	ASN_OBJECT_ID	RO
1.3.6.1.2.1.1.3.0	178	sysUpTime	TIMETICKS	RO
1.3.6.1.2.1.1.4.0	STE2 PLUS	sysContact	ASN_OCTET_STR	R/W
1.3.6.1.2.1.1.5.0	STE2 PLUS 5905-D352	sysName	ASN_OCTET_STR	R/W
1.3.6.1.2.1.1.6.0		sysLocation	ASN_OCTET_STR	R/W
1.3.6.1.2.1.1.7.0	72	sysServices	ASN_INTEGER	RO
1.3.6.1.2.1.11.1.0	0	snmpInPkts	COUNTER	RO
1.3.6.1.2.1.11.2.0	0	snmpOutPkts	COUNTER	RO
1.3.6.1.2.1.11.3.0	0	snmpInBadVersions	COUNTER	RO
1.3.6.1.2.1.11.4.0	0	snmpInBadCommunityNames	COUNTER	RO
1.3.6.1.2.1.11.5.0	0	snmpInBadCommunityUses	COUNTER	RO
1.3.6.1.2.1.11.6.0	0	snmpInASNParseErrs	COUNTER	RO
1.3.6.1.2.1.11.8.0	0	snmpInTooBigs	COUNTER	RO

Download the **MIB file** in the System section (Download MIB file).

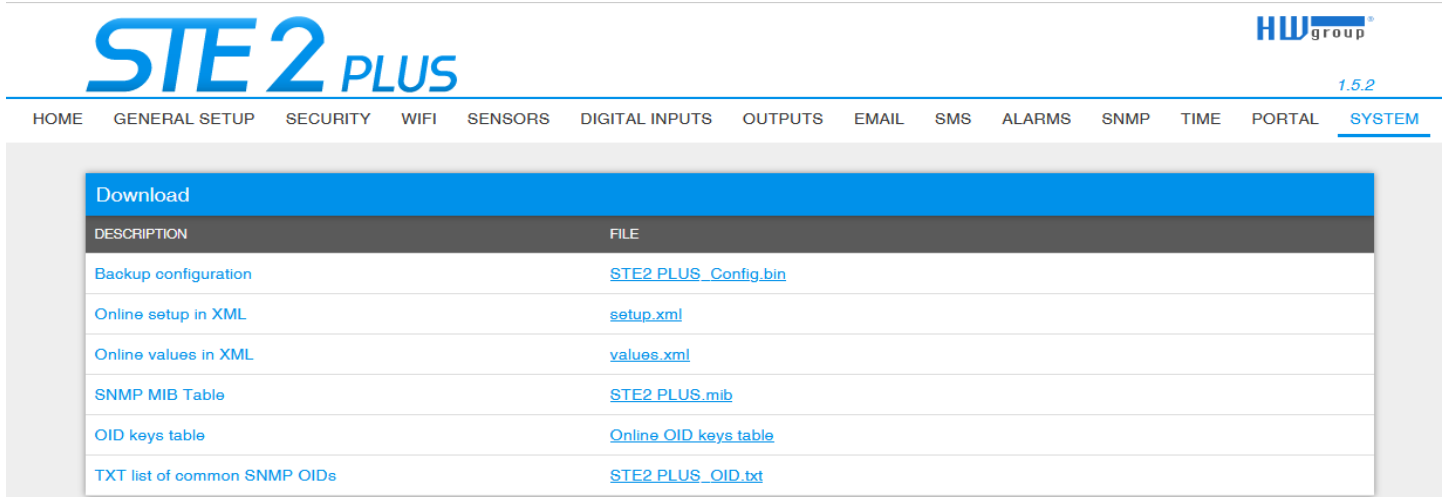

DESCRIPTION	FILE
Backup configuration	STE2 PLUS _Config.bin
Online setup in XML	setup.xml
Online values in XML	values.xml
SNMP MIB Table	STE2 PLUS.mib
OID keys table	Online OID keys table
TXT list of common SNMP OIDs	STE2 PLUS_OID.txt

Time tab

STE2 PLUS

1.5.1

HOME GENERAL SETUP SECURITY WIFI SENSORS DIGITAL INPUTS OUTPUTS EMAIL SMS ALARMS SNMP **TIME** PORTAL SYSTEM

SNTP Settings

NAME	VALUE	DESCRIPTION
SNTP Server	<input type="text" value="europe.pool.ntp.org"/>	IP Address or DNS Name
Time Zone	1 : 0 min	Number -12 ... +13
Summertime	<input checked="" type="checkbox"/> Central European	last Sun March 2:00 - last Sun October 3:00
Interval	1h	Sync period: Off/1h/24h

[Save](#)

Time Settings

NAME	VALUE	DESCRIPTION
Time	<input type="text" value="16:32:36"/>	hh:mm:ss
Date	<input type="text" value="19.02.2023"/>	dd.mm.yyyy

[Set browser's datetime](#)
[Set Time manually](#)

SNTP Log

Debug log window.

[Synchronize](#)

SNTP Settings section

- **SNTP Server** - The IP address or domain address of the time synchronization server; europe.pool.ntp.org.
- **Time Zone** - Set the time zone of the device location. Used to set the correct system time. Necessary for correct recording of measured values.
- **Summertime** - Enable daylight saving time. Used to set the correct system time. Required for correct recording of measured values.
- **Interval** - Interval of time synchronization with the server.

Time Settings section

Allows you to fill in the current date and time manually when synchronization with the time server cannot be used.

SNTP Log section



The Sync button is used to perform an instant synchronization with the time server. It can also be used to test the settings.

Portal tab

Configure parameters how to connect the device to remote SensDesk Technology based portal. It is using HTTP connection, HWg-PUSH protocol. More information about the protocol or support of portal solutions is available on the website <http://www.HW-group.com>.

The default preconfigured portal is www.HWg-cloud.com, but **you have to enable Portal** in the device web configuration and define portal account name and password.

There are several portals available besides www.HWg-cloud.com or www.SensDesk.com (provided by HW group). Check the **Portal providers**.



1.5.1

HOME
GENERAL SETUP
SECURITY
WIFI
SENSORS
DIGITAL INPUTS
OUTPUTS
EMAIL
SMS
ALARMS
SNMP
TIME
PORTAL
SYSTEM

Portal Message

Portal disabled_

Portal settings

NAME	VALUE	DESCRIPTION
Portal	<input type="checkbox"/>	Portal Enable/Disable
Server Address	<input type="text" value="http://hwg-cloud.com/portal.php"/>	IP Address or DNS Name
IP Port	<input type="text" value="80"/>	Default 80
Team (provided by portal)	<input type="text"/>	Push device access parameters Please have a look at My Team on Sensdesk
Team Password (provided by portal)	<input type="text"/>	

AutoPush settings

ID	NAME	TYPE	CURRENT VALUE	AUTOPUSH
6291	Sensor 6291	Temp.	89.0 °C	<input type="text" value="5.0"/>
6292	Sensor 6292	Humidity	50.2 %RH	<input type="text" value="5.0"/>

Portal Debug Log

NAME	VALUE	DESCRIPTION
Push Period:	60	[seconds]
Log Period:	0	[seconds]
Current Push Timer:	0	[seconds]
Current Log Timer:	0	[seconds]
Current Check Timer:	0	[seconds]
AutoPush Block Timer:	0	[seconds]
Retransmit number:	0	

Portal Message section

Feedback from the portal containing e.g. links to graphs, etc. Depends on the portal type.

Portal settings section

- **Portal** - Enables or disables this function.
- **Server address** - Complete URL of the remote server.
Connection to HWg-cloud.com portal is preset, but without account name.
- **IP Port** - Port where the portal listens.
- **Team** - Name of the Portal Team to which the device should be assigned.
You can find it on your portal on the "**My Team**" tab.
- **Team Password** - Password of the Team (HWg Push protocol) to which the device should be assigned.

The screenshot shows the HWg Cloud portal interface. The user is logged in as 'rehak' and is viewing the 'My team' settings page. The page title is 'Team rehak'. The breadcrumb trail is 'Home > Settings'. The main content area is divided into two sections: 'PORTAL SETTINGS' and 'LIMITS'.

PORTAL SETTINGS

This is credential for your devices.

Portal URL:	http://hwg-cloud.com/portal.php
Portal port:	80
Team:	rehak
Team password:	cBs6TZ

PUSH configurations:
[Default](#)
[NB Power Default](#)
[NB Battery Default](#)
[Frozen](#)

LIMITS

Team:	Team rehak
Date of expiration:	-
Action - E-mail limit:	- Unlimited - 1 used
Action - Set output limit:	- Unlimited - 0 used
Action - SMS limit:	- Unlimited - 0 used
Action - SNMP trap limit:	- Unlimited - 0 used
Dashboard limit:	1 1 used
Device limit:	20 1 used
Device group limit:	- Unlimited - 0 used
Location limit:	- Unlimited - 2 used
Log limit (days):	10
Multigraph limit:	0 0 used
Notice limit:	- Unlimited - 1 used
Report limit:	0 0 used
Target limit:	- Unlimited - 1 used
User limit:	4 1 used
User SNMP enabled:	Enabled
values.xml enabled:	Enabled

Default dashboard: [Team dashboard rehak](#)

Default permission group:

Default SMS gateway address:

Portal Debug Log section

For debugging only. Event counters + Debug window for sending data to the portal.

- **Push Period** – Period of sending data to the remote portal. The period is determined by the portal and cannot be changed by the user.
- **Log Period** – Period of storing data for the portal in the device cache. The period is determined by the portal and cannot be changed by the user.
- **Current Push Timer** – Timer indicating the time remaining until sending data to the portal.
- **Current Log Timer** – Timer indicating the time remaining until saving the data for the portal in the cache.
- **AutoPush Block Timer** – Time of incidents for AutoPush. If the permitted number of incidents for one Push period is exceeded, the AutoPush function will be blocked.
- **Retransmit number** – Counts the number of invalid Push attempts.
- **Manual Push** – Button for instant sending of data to the portal.
- **Websocket state** – Status of websocket service for portal connection (must be enabled as “Check period” on portal first).

The AutoPush functionality

The device sends sensor data to the online portal at regular intervals defined by the portal. For the HWg-cloud.com portal, the default interval is every 15 minutes and cannot be changed by the user.

Alarming to the portal is based on 2 functions:

- **Notice Range** – alarming is fully managed in the portal. Reaction time up to 15 min.
- **SD SafeRange** - alarming is managed in the portal, but MIN & MAX values of the Safe Range are synchronized with the device. This helps respond to alarms faster when sensor values pass the alarm limits.

AutoPush settings for each Sensor

AutoPush sends data to the portal faster when sensor values change by a certain amount since the last upload. When this happens, the STE2 device automatically connects to the portal and sends updated values for all sensors.

System tab

The screenshot shows the STE2 PLUS web interface. At the top, there is a navigation menu with options: HOME, GENERAL SETUP, SECURITY, WIFI, SENSORS, DIGITAL INPUTS, OUTPUTS, EMAIL, SMS, ALARMS, SNMP, TIME, PORTAL, and SYSTEM (which is highlighted). Below the menu, there are three main sections:

- Download:** A table with two columns: DESCRIPTION and FILE. It contains links for Backup configuration (STE2 PLUS_Config.bin), Online setup in XML (setup.xml), Online values in XML (values.xml), SNMP MIB Table (STE2 PLUS_mib), OID keys table (Online OID keys table), and TXT list of common SNMP OIDs (STE2 PLUS_OID.txt).
- Syslog (UDP):** A configuration section with a table for NAME and VALUE. It includes an 'Enable' checkbox and a 'Syslog address:port' input field. A note states: "If not using default port 514, add port number after the address e.g. 192.168.10.20:1051." A 'Save' button is located at the bottom right.
- System:** A table displaying system information:

NAME	VALUE
Product Name:	STE2 PLUS
Serial Number:	6008190001
Eth MAC Address:	00:0A:59:05:D3:52
Wifi STA MAC Address:	00:0A:59:05:D3:53
Version:	1.5.1
Build:	2228
Compile time:	Feb 13 2023, 16:17:25
Up Time:	505 [s]
Demo Mode:	Demo Mode
Network Upgrade	Read available version:--- Start Network Upgrade:---
Upload Firmware or Configuration:	Zvolit soubor Nevybrán žádný soubor Upload

Download section

- **Backup configuration** - Device configuration backup in BIN format. Click on the link to save the current device configuration after its final settings for potential restore purposes.
- **Online setup in XML** - Configuration backup in XML format. Click on the link to save the current device configuration after its final settings for potential restore purposes.
- **Online values in XML** - Current values in XML format. Click on the link to save the current device configuration after its final settings for potential restore purposes.
- **SNMP MIB Table** - SNMP MIB file. MIB file address containing the definition of SNMP variables.

- **OID keys table** - The function will draw up the entire tree of variables with an indication of the entire SNMP OID and explanations of the variable type.
- **TXT list of common SNMP OIDs** - Overview of the most important OID from the MIB table.

Syslog (UDP) section

- **Enable** – Enables the Syslog (UDP) function.
- **Syslog address[:port]** – The IP address and (optional) port of remote syslog server. Default port is 514. If the syslog server listens on different port, add port to the IP address e.g. 192.168.10.20:1051.

System section

- **Product Name** - Device name (type).
- **Serial Number** - Device serial number.
- **Eth MAC Address** - MAC address of the device for cable connection.
- **WiFi STA MAC Address** - MAC address of the device for WiFi connection.
- **Version** - Firmware version. Serves for diagnostic purposes when troubleshooting.
- **Build** - Serves for diagnostic purposes when troubleshooting.
- **Compile time** - Firmware compile time. Serves for diagnostic purposes when troubleshooting.
- **Up Time** - Runtime of the device since the last switching on or restarting. Serves for diagnostic purposes when troubleshooting.
- **Demo mode** - Active demo mode prevents any changes in your device configuration. In this mode, users can browse and view all the web interface pages, but they are not allowed to change any values. A device with this setting can be placed on the public Internet with no risk of changes in its configuration. Demo mode can be turned off in the same way after entering the password.
- **Read available version** - Lists the latest version of firmware on the HW group update server.
- **Start Network Upgrade** - Launches a firmware upgrade from the HW group update server.
- **Upload Firmware or Configuration** - Install newer firmware or configuration file to the device.

Restore configuration may not work if there is too big difference in firmware versions.

Factory reset button

Restores factory settings. By default, DHCP setup is enabled. If the device does not receive an address within 60 seconds of switching it on, it defaults to 192.168.10.20 as the default IP. Neither the username nor the password is defined by default.

Restart button

Restarts the device (only reboot, no default settings).

Technical parameters

Ethernet	
Interface	RJ45 (10/100BASE-T)
Supported protocols	IP: ARP, TCP/IP (HTTP, HTTPS, SNMP, SMTP, HWg-Push, netGSM, TLS), UDP/IP (SNMP, Syslog)
SNMP	Versions 1, 3
WiFi	
Supported standards	802.11 b/g/n
Frequency	2.4GHz
Output	+19.5 dBm output power in 802.11b mode +16 dBm for 802.11n
Security	WEP / WPA / WPA2 PSK
Antenna	Internal
External sensors	
Port/connector	Port1, Port2 / RJ11 (1W-UNI)
Values limit	Up to 15 sensor values (°C, %RH, WLD, Voltage ...)
Sensor type	Only sensors from HW group s.r.o.
Sensors/distance	2× Max. 60 meters total length (per each RJ11 port)
DI INPUTS (Dry Contact Inputs)	
Port/connector	I1, I2 / ø2 mm terminal block
Type	Digital Input (supports NO/NC Dry contact)
Sensitivity	Sensitivity 1 (On) = 0-500 Ohm
Max. distance	Up to 50m
Power supply	
Power voltage	5V / 250 mA
Connector	Connector Jack Ø3.5 x 1.35 / 10 [mm]
PoE (Power over Ethernet)	PoE (Power over Ethernet) RJ45 - IEEE 802.3af Class 0
LED	
Link	Yellow – Ethernet connection state
Activity	Green – Ethernet activity
Alarm	Port 1 – Alarm SENS – LED is lit in case of alarm active on a sensor Port 2 – Alarm DI – LED is lit in case of alarm active on a DI
2x DI input	Green – LED indicates switching on the DI Input
WiFi	Blue – connection state in operation (shining), search indicator (flashing slowly) and connecting (flashing quickly)
Button	
Reset	Restore default settings: hold and connect power supply, keep holding button for 5 seconds.
Other parameters	
Operating temperature	-10 to 60 °C (device operating temperatures) Sensors temperature range can be very different
Dimensions/weight	98 × 68 × 33 (W × H × D) / 91 g
Elmag. radiation	CE / FCC Part 15, Class B
Elmag. compatibility	EN 61326-1:2013, EN 61010-1:2010, EN 55011:2009, EN 62311:2008

Physical dimensions

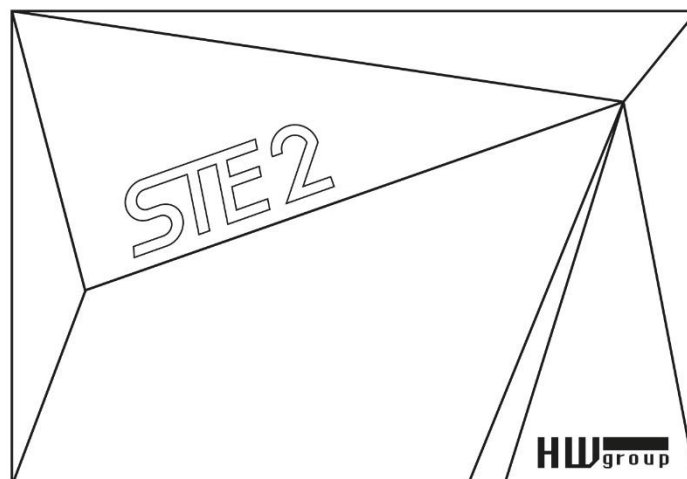
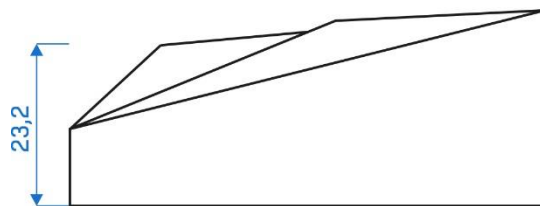
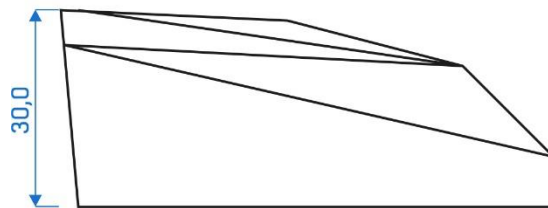
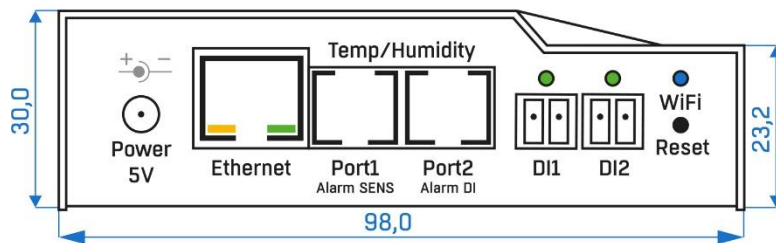
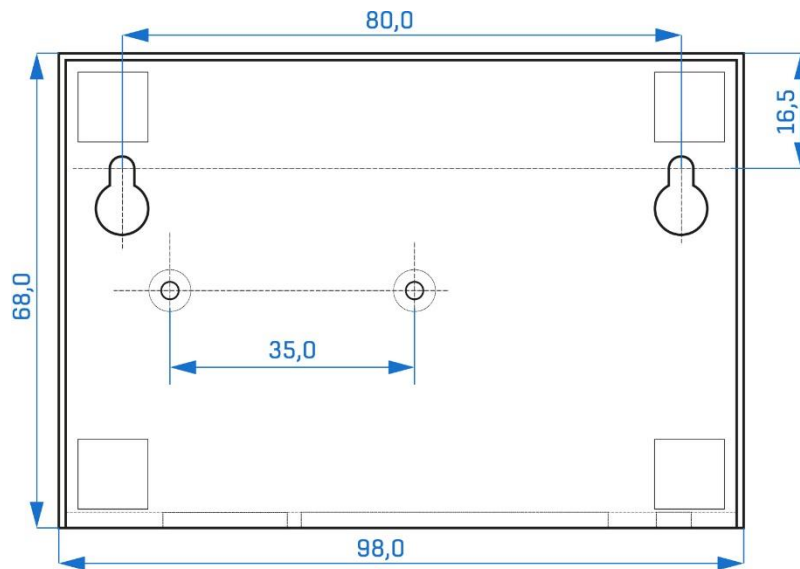

Optional DIN mount

DIN Rail box set - A mounting kit for installing HWg devices to a DIN rail.

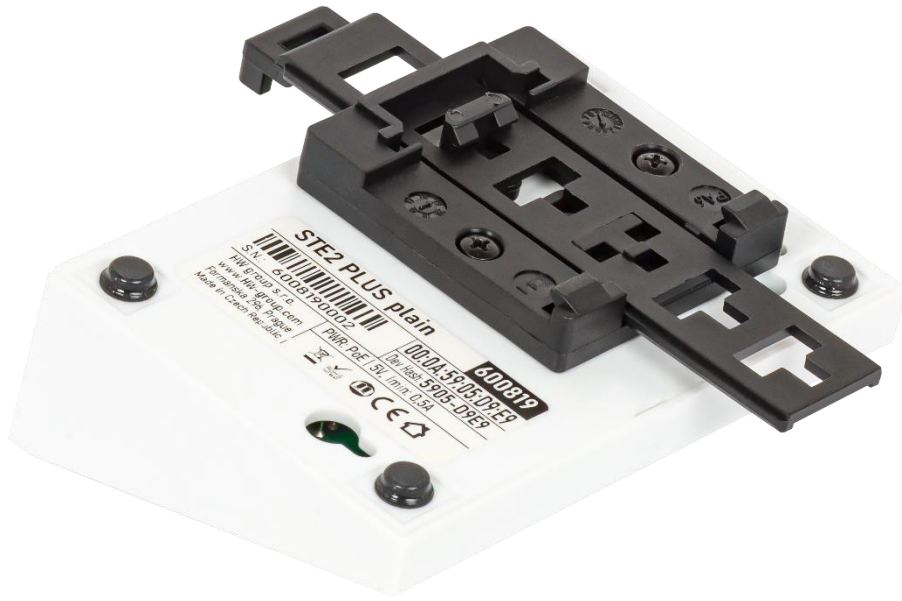

WiFi Radio

Description	Min	Typical	Max	Unit
Input frequency	2412	-	2484	MHz
Tx power				
The output power of PA for 72.2 Mbps	13	14	15	dBm
The output power of PA for 11b mode	19,5	20	20,5	dBm
Sensitivity				
DSSS, 1 Mbps	-	-98	-	dBm
CCK, 11 Mbps	-	-91	-	dBm
OFDM, 6 Mbps	-	-93	-	dBm
OFDM, 54 Mbps	-	-75	-	dBm
HT20, MCS0	-	-93	-	dBm
HT20, MCS7	-	-73	-	dBm
HT40, MCS0	-	-90	-	dBm
HT40, MCS7	-	-70	-	dBm
MCS32	-	-89	-	dBm
Adjacent Channel Rejection				
OFDM, 6Mbps		37		dB
OFDM, 54Mbps		21		dB
HT20, MCS0		37		dB
HT20, MCS7		20		dB

WiFi signal strength

What is signals strength

WiFi is a radio signal and it has limitations in reach given firstly by the transmission output and by the quality and shape of the antennas. Signal strength is indicated in decibels per milliwatt of output (dBm), often (incorrectly) simplified to "dB". Signal strength has a negative value and it applies that the lower the value (a higher number after the negative sign), the worse.

The decibel unit is non-dimensional and expresses the logarithm of a ratio of two values. In our case, it is the ratio of received output to an etalon of 1 mW:

$$dBm = 10 * \log_{10} \frac{P_1}{1 \text{ mW}}$$

This means that if you have a signal of -54 dBm, it is higher (better) than a value of -82 dBm.

Effect of device location with relation to WiFi transmitter

In terms of sensitivity, flat antennas perform equally well or even better than multi-directional antennas (provided that the transition connector is excluded). However, the main disadvantage of flat antennas is their sensitivity to the position of the device relative to the connection point.

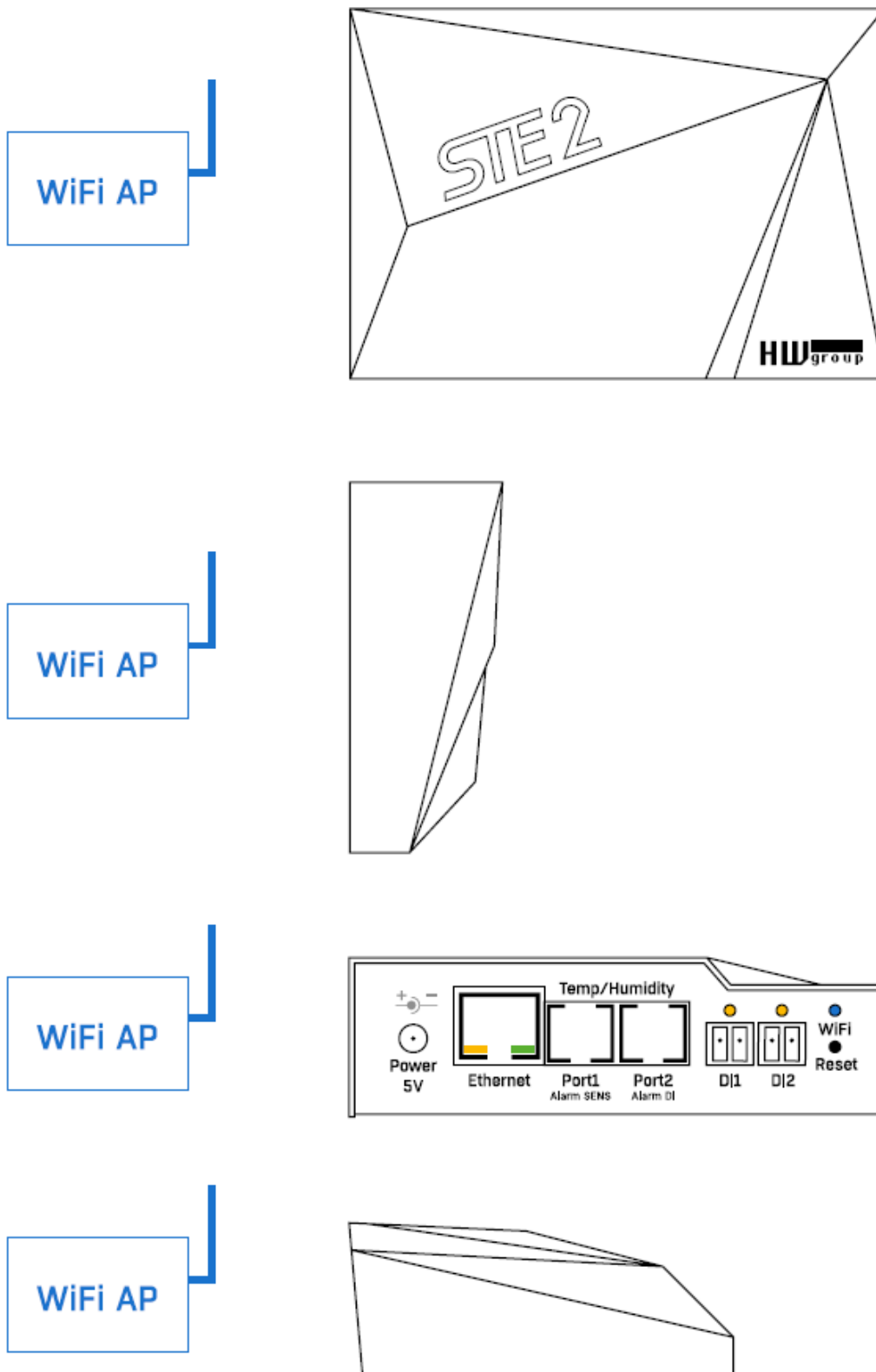

Supported interfaces

Digital Inputs

Dry contact, simple door contact or relay output can be connected to the green terminal block.

DIs are galvanically connected to the power supply.

- **Not switched input** has a value of „**0 (Off)**“.
- **Switched input** is identified as „**1 (On)**“, Ohmic resistance 0 Ω to 500 Ω .



Connection parameters:

- Maximum cable length: 50 meters.
- Supported detectors: Any dry contact.
- Alarm alert setting for each DI input
 - Alarm Disabled.
 - Alarm state = 1 (Active if close)
 - Alarm state = 0 (Active if Open)
- Alarm target:
 - None - No reaction.
 - Defined target (Notify of Alarm by sending an Email or SMS).
- Reading period: 800 ms.
- **Range of ID sensors:** DI (Digital Inputs) use address ID 1 or 2.
- **Name:** Each one DI can be named independently with up to 22 characters.
- **Sensor disconnection detection:** No, the disconnected sensor returns to the value „**0 (Off)**“.

Available detectors you can connect to DI port:

- Water flood detector (spot detection)
- WLD (Water Leak Detection) Relay with an external sensing cable
- Airflow detector
- Door contact detector
- PIR motion detector
- Gas leak detector
- Power presence (110/230V) detector
- Vibration detector

Sensors RJ11 (1W-UNI bus)

Digital sensor bus, each sensor has a unique ID.

- STE2 PLUS has 2 RJ11 ports
- Each port support max. distance 60m.
- Power: 5 V / 20 mA from RJ11 port.
- You can connect one RJ11 sensor to each port
- You can connect several physical RJ11 sensors to one port. Sensors can be daisy-chain with respect to total max distance.
- To help sensors daisy-chain, some sensors have 2 RJ11 ports.
- Avoid star topology (RJ11 splitters).
- Only sensors from HW group are supported.
Do not connect any other sensors, it can damage device.

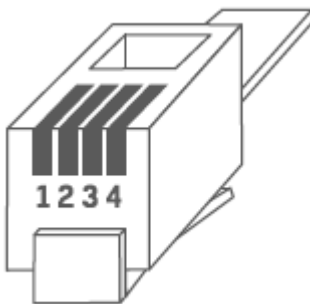

RJ11 (1W-UNI)		
1.	-	Not used
2.	Data	2 Data Transmit Data
3.	GND	3 GND Ground
4.	+5V	4 +5V Power

Note:

If a cable line is more than 60 meters from one connector on the device, we can't guarantee it will work perfectly. It depends on the type of cable, how the line is set up, and the environment where it's installed.

In case of issues, check your cable and RJ11 connectors quality.

Sensor values limit

Several sensor values can be connected to the device. Sensors can be daisy-chained from RJ11 port. One physical sensor can measure several sensor values ($^{\circ}\text{C} + \%RH = 2$ sensor values).

- STE2 PLUS maximum limit is 15 sensor values in total.
- There can be limit based on powering external sensors. Contact our supports.

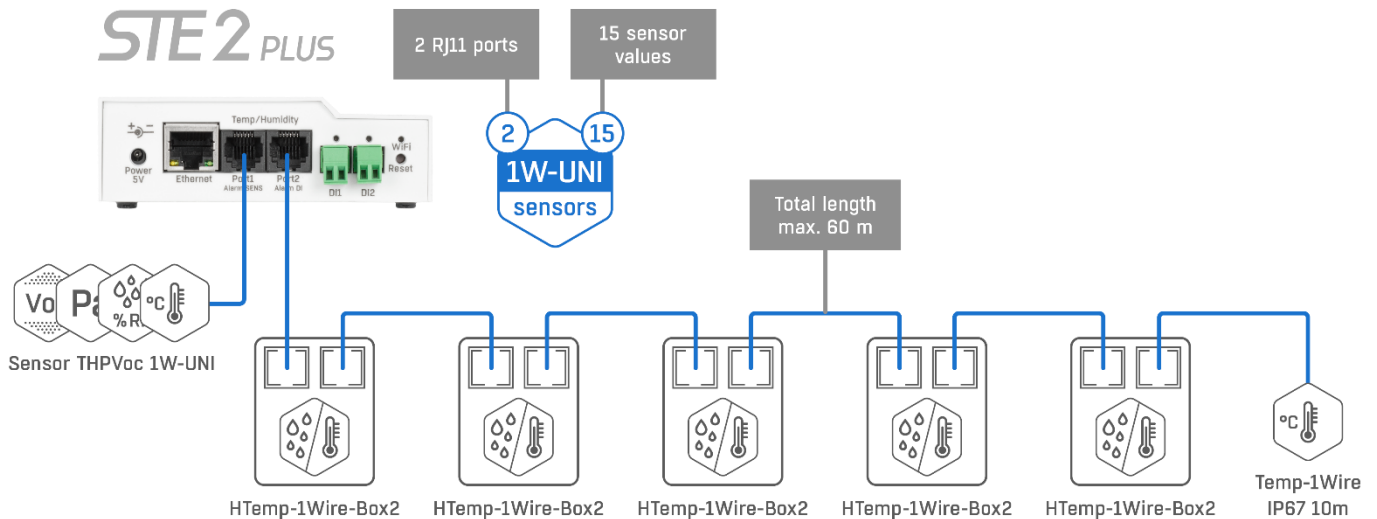

Available 1W-UNI sensors:

- Temperature sensors (Indoor / Outdoor / Cryo)
- Calibrated temperature sensors
- Relative Humidity sensors (Indoor / Outdoor)
- CO2 & VOC sensors
- Light sensor
- AC / DC Current sensors
- AC Voltage sensor (0-230V)
- 4-20 mA sensors (converter) for industrial probes
- Water flood detector (spot detection)
- WLD (Water Leak Detection) with an external sensing cable

Connecting STE2 to the SensDesk portal

1. Connect the device to the computer network and set the network parameters (see the [First Steps](#) chapter).

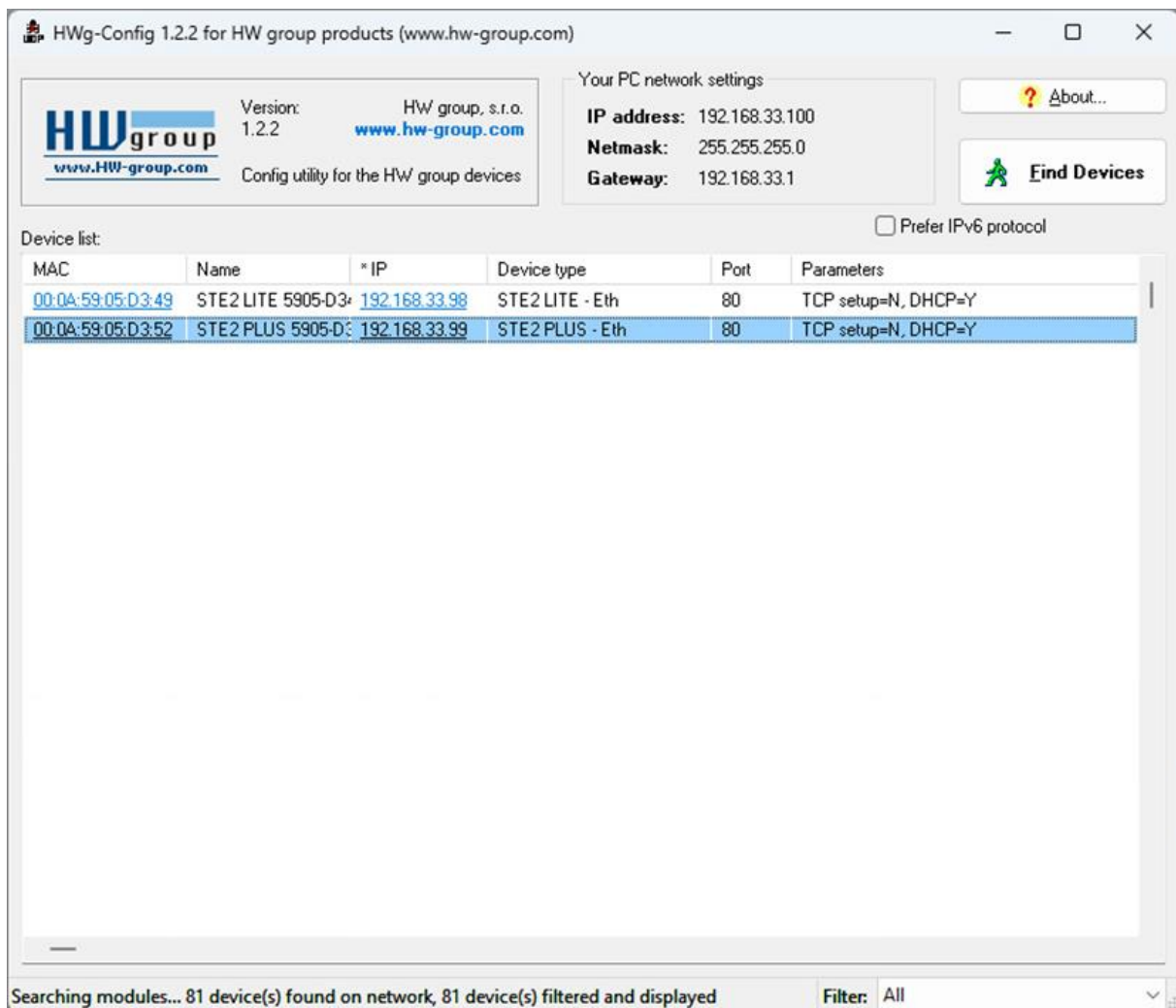

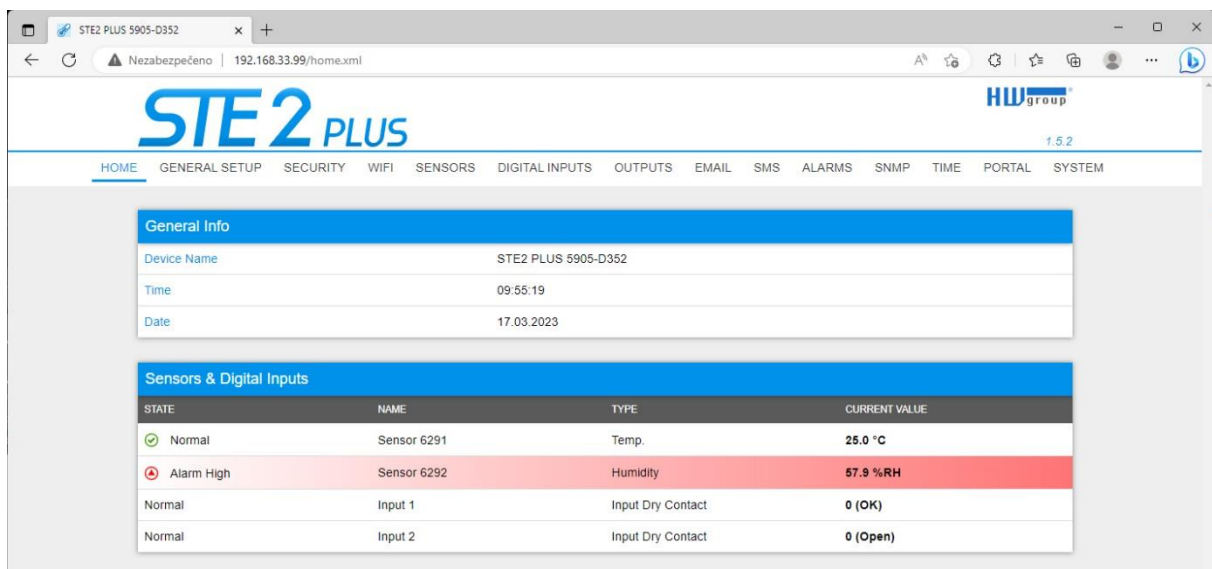

2. Check the device website:



3. Check the Enable Portal option and save the changes using the Save button in the bottom right corner of the window.

Then click the Manual Push button in order to activate the portal function. Instead of "Portal disabled", a link HWg-Cloud.com: register your IP sensor should appear in the Portal Message field. Click this link in order to get to the HWg-Cloud.com portal.



1.5.1

HOME GENERAL SETUP SECURITY WIFI SENSORS DIGITAL INPUTS OUTPUTS EMAIL SMS ALARMS SNMP TIME
PORTAL
SYSTEM

Portal Message

HWg-cloud: *Check sensor online (2023-04-17 14:03:09 UTC)_

Portal settings

NAME	VALUE	DESCRIPTION
Portal	<input checked="" type="checkbox"/>	Portal Enable/Disable
Server Address	<input type="text" value="http://hwg-cloud.com/portal.php"/>	IP Address or DNS Name
IP Port	<input type="text" value="80"/>	Default 80
Team (provided by portal)	<input type="text" value="Mr. Screenshot"/>	Push device access parameters Please have a look at My Team on Sensdesk
Team Password (provided by portal)	<input type="password" value="*****"/>	

AutoPush settings

ID	NAME	TYPE	CURRENT VALUE	AUTOPUSH
416	Liquid	HWg-UNI	42.67 m3	<input type="text" value="0.0"/>
864	Sensor 864	Temp.	21.9 °C	<input type="text" value="5.0"/>
865	Sensor 865	Humidity	35.4 %RH	<input type="text" value="5.0"/>
3323	Flood	HWg-UNI	0 WLD	<input type="text" value="0.0"/>
5497	Sensor 5497	Humidity	39.9 %RH	<input type="text" value="5.0"/>
6497	Sensor 6497	Temp.	22.5 °C	<input type="text" value="5.0"/>
61539	AC_230V	HWg-UNI	233.2 V	<input type="text" value="0.0"/>

Portal Debug Log

NAME	VALUE	DESCRIPTION
Push Period:	30	[seconds]
Log Period:	10	[seconds]
Current Push Timer:	1	[seconds]
Current Log Timer:	3	[seconds]
Current Check Timer:	0	[seconds]
AutoPush Block Timer:	0	[seconds]
Retransmit number:	0	

17.04.2023, 17:02:54
 Push data start
 Server Address: http://hwg-cloud.com/portal.php
 Push SUCCESS

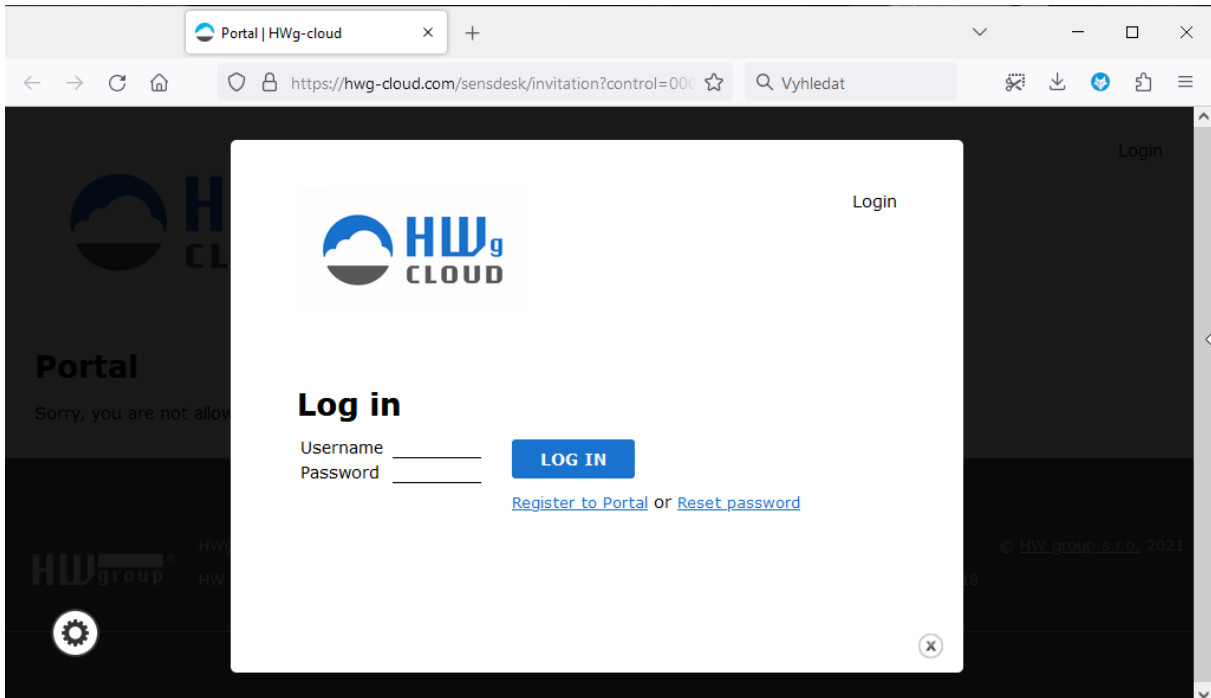

4. In case you already have a user account, please enter your login details and the device will be automatically assigned to your account. If you do not have a SensDesk account yet, click the Register and a registration form will be shown.

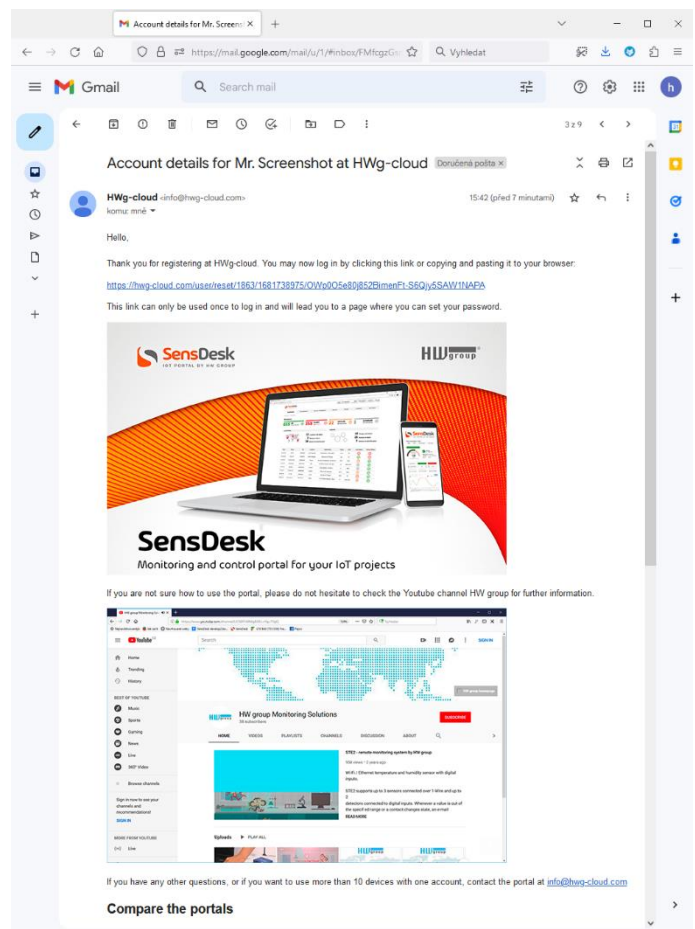

5. Enter the login details for your new account and the correct email address.

This email address has to be unique for the server (cannot be already registered by another user).

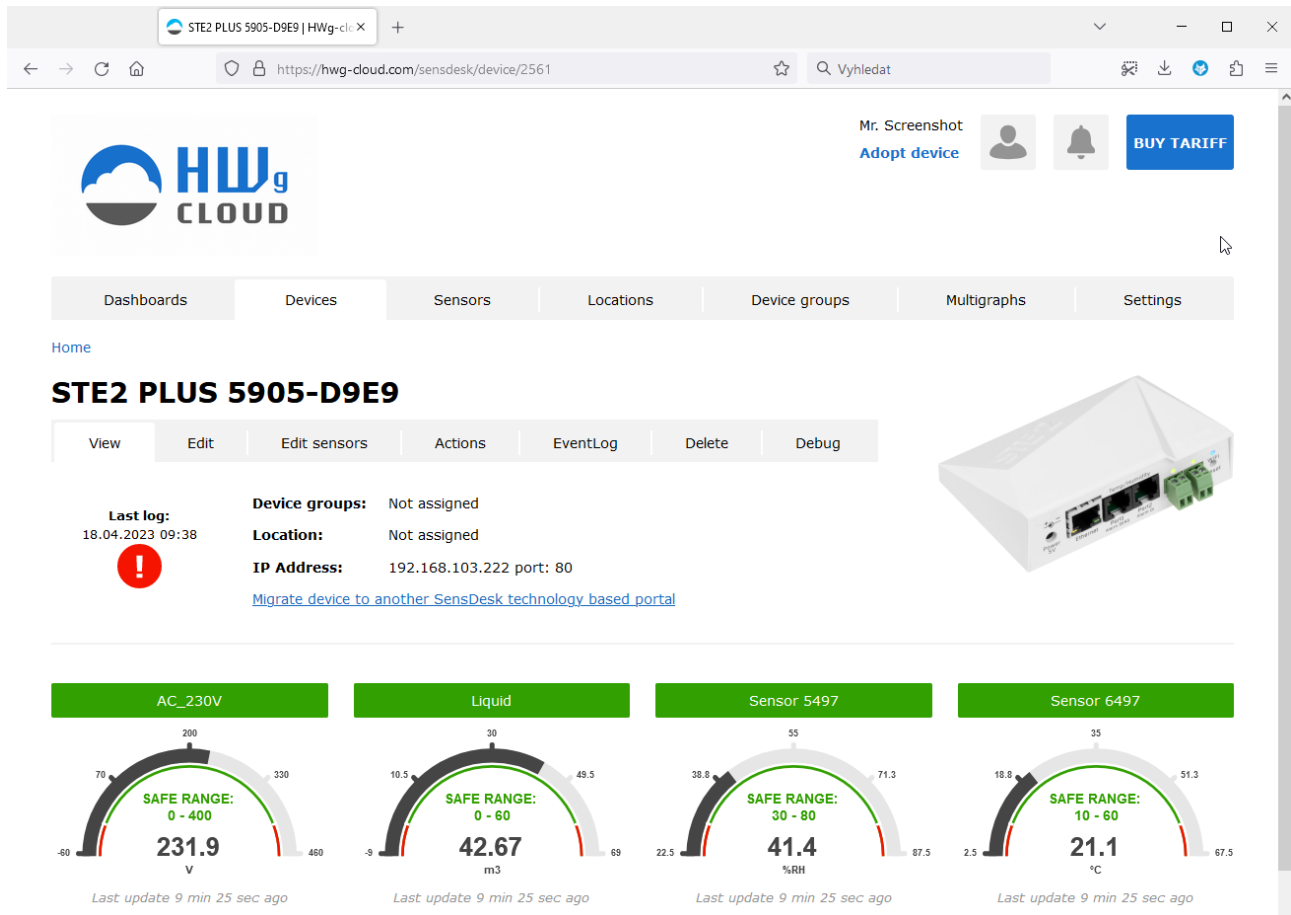

6. By activating the account, you will be redirected to the Devices > View page.

At this moment, the data-sending period is set to 10 seconds to show the sensors functionality. This quick communication to portal is active only for approximately 15 minutes after the first device registration, then the push period changes to standard 15 minutes.

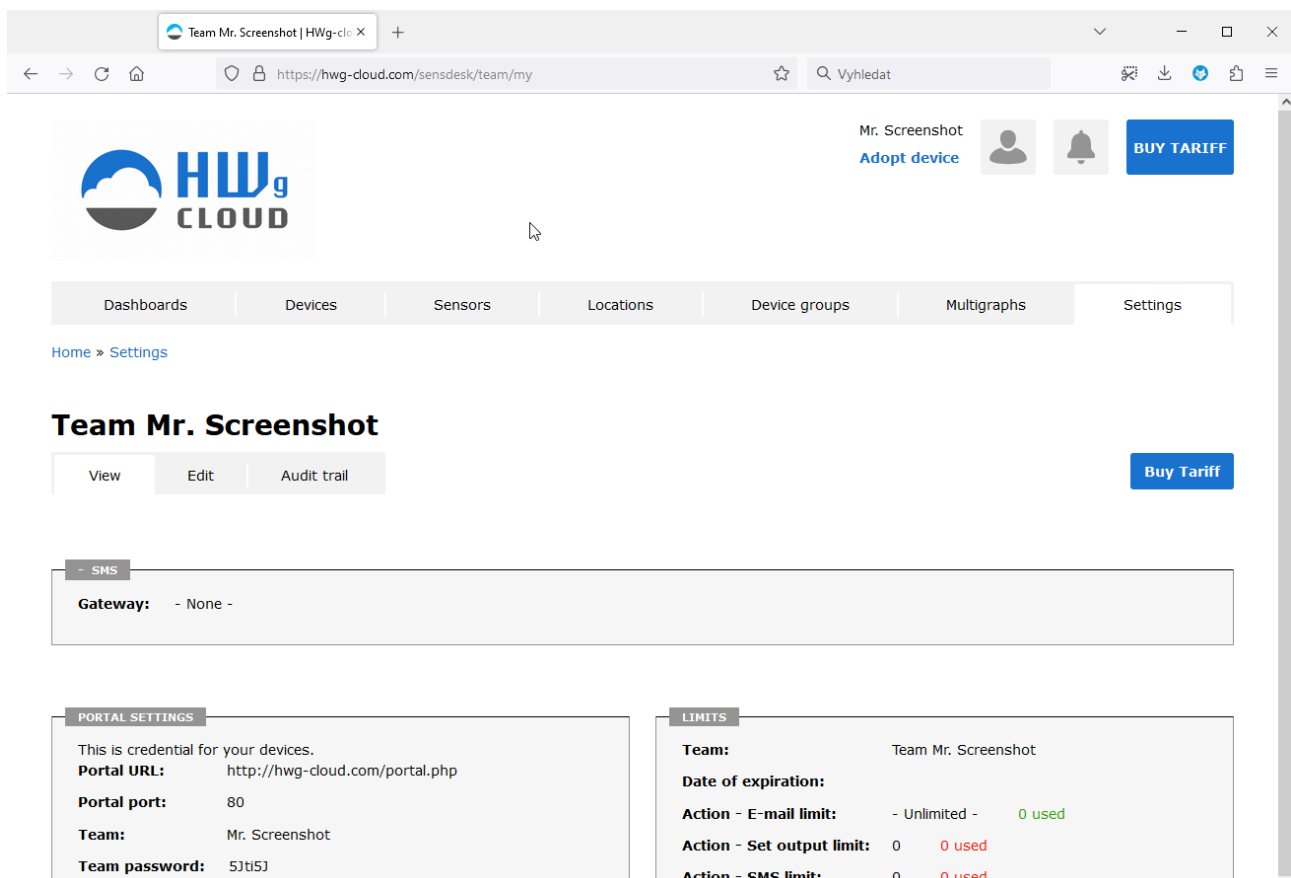

7. If you check the Teams link, you will find your Team Password.

This password, together with your login name, identifies the device in communication with your account and in the communication of mobile applications with SensDesk. The password cannot be changed and for security reasons, it is different to the login password.

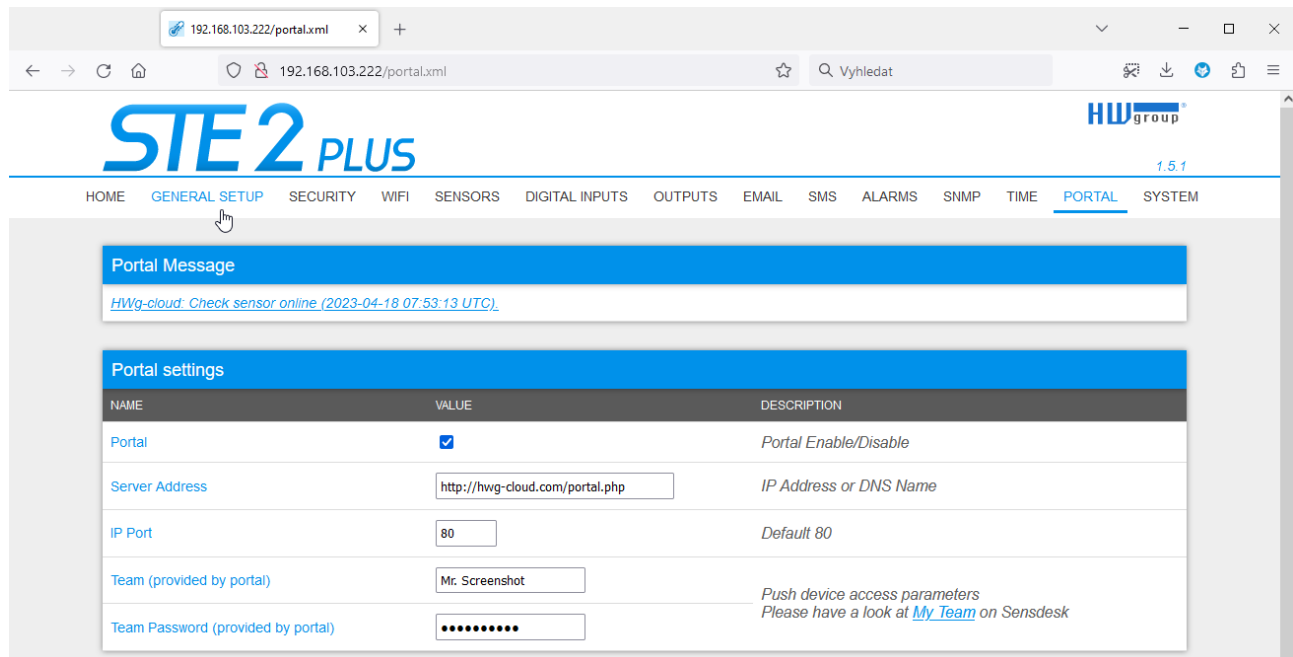

8. Team Password can be used in devices to skip the logging procedure during assigning the device to your portal account, or in mobile applications:

Portal function periodically sends the data to a remote server and the sending period is set by this server.

AutoPush is a function allowing unusual measured data sending, beside the periodical logging, in case that the value change is higher than the AutoPush delta parameter.

HWg Monitor - mobile app

HWg Monitor allows users to check values from one or more HWg devices regularly. It reads data from either the LAN or the Portal (Cloud) and mainly helps to display sensor values.

The app also allows you to sort sensors by device or prioritize which ones show up first. Sensors in alarm or disconnected devices are marked with different colors.

Additionally, HWg Monitor can control Digital Outputs (DO) on Poseidon2 and Damocles2 devices connected directly to the LAN, as well as devices connected to the Portal.

- Mobile App for iOS and Android
- Can be used on Mobile phones, Tablets, Android compatible devices (TV).
- Display values from Sensors, DI, DO
- Data input
 - LAN devices (All HWg products)
 - Cloud Portal
 - SensDesk.com (HWg-cloud.com is not supported)
 - Portal Providers



HWg Monitor: Define sensor values zoom as you need



Specifics of selected SensDesk Technology portals:

The HWg Monitor application can work with all SensDesk Technology portals, but not all may have active support for this application. Support depends on the activation of XML API on the portal, which may be enabled or disabled by its provider. The HWg-Cloud.com portal has this support turned off and is only available on the paid version of SensDesk.com. Portals from other providers may have different settings, so users should ask their portal provider for support for this application.

Basic features of the HWg Monitor application:

- An unlimited number of monitored devices and sensors.
- Two types of data sources (Data source).
 - Direct communication with STE2, Poseidon2, Damocles2, HWg-PWR, WLD2 units.
 - Portals (Cloud) from the SensDesk Technology family with enabled integration (API) through XML (SensDesk.com, HWportal.cz, SensDesk.mcs-nl.com, and others).
- Option to select preferred sensors (favorites).
- Sorting options by name or status.
- Row or tile display.
- Integrated HWg config for searching devices on a local network.
- Widget for a quick preview.
- Output control on directly connected Poseidon2 and Damocles2 units.
- Simple application for iOS and Android.
- Optional number of tiles on the screen for setting up large screens.

Find out more: <https://www.hw-group.com/software/hwg-monitor>

Firmware upgrade in STE2 PLUS units

1) Open the device web interface in the System tab.

The screenshot shows the web interface of the STE2 PLUS device. The browser address bar displays '192.168.33.99/system.xml'. The page title is 'STE2 PLUS' and the version is '1.5.2'. The navigation menu includes: HOME, GENERAL SETUP, SECURITY, WIFI, SENSORS, DIGITAL INPUTS, OUTPUTS, EMAIL, SMS, ALARMS, SNMP, TIME, PORTAL, and SYSTEM (selected).

The 'Download' section contains the following table:

DESCRIPTION	FILE
Backup configuration	STE2 PLUS_Config.bin
Online setup in XML	setup.xml
Online values in XML	values.xml
SNMP MIB Table	STE2 PLUS_mib
OID keys table	Online_OID_keys_table
TXT list of common SNMP OIDs	STE2 PLUS_OID.txt

The 'Syslog (UDP)' section includes a configuration form:

NAME	VALUE
Enable	<input type="checkbox"/>
Syslog address[port]	<input type="text" value="address:port"/>

If not using default port 514, add port number after the address e.g. 192.168.10.20:1051.

A 'Save' button is located at the bottom right of the Syslog section.

The 'System' section displays the following information:

NAME	VALUE
Product Name:	STE2 PLUS
Serial Number:	6008190001
Eth MAC Address:	00:0A:59:05:D3:52
Wifi STA MAC Address:	00:0A:59:05:D3:53
Version:	1.5.2
Build:	2290
Compile time:	Mar 15 2023, 09:53:28
Up Time:	2032 [s]
Demo Mode:	Demo Mode
Network Upgrade	Read available version:--- Start Network Upgrade:---

2) The System section contains items to identify and download the current FW version.

System	
NAME	VALUE
Product Name:	STE2 PLUS
Serial Number:	6008190001
Eth MAC Address:	00:0A:59:05:D3:52
Wifi STA MAC Address:	00:0A:59:05:D3:53
Version:	1.5.2
Build:	2290
Compile time:	Mar 15 2023, 09:53:28
Up Time:	2032 [s]
Demo Mode:	Demo Mode
Network Upgrade	Read available version:--- Start Network Upgrade:---
Upload Firmware or Configuration:	<input type="button" value="Zvolit soubor"/> Nevybrán žádný soubor <input type="button" value="Upload"/> <input type="text"/>

3) Read available version – Serves to identify and display the current firmware version on the update server. Click on the Read available version link.

System	
NAME	VALUE
Product Name:	STE2 PLUS
Serial Number:	6008190001
Eth MAC Address:	00:0A:59:05:D3:52
Wifi STA MAC Address:	00:0A:59:05:D3:53
Version:	1.5.2
Build:	2290
Compile time:	Mar 15 2023, 09:53:28
Up Time:	2032 [s]
Demo Mode:	Demo Mode
Network Upgrade	Read available version:--- Start Network Upgrade:---
Upload Firmware or Configuration:	<input type="button" value="Zvolit soubor"/> Nevybrán žádný soubor <input type="button" value="Upload"/> <input type="text"/>

4) Start Network Upgrade – Serves to upgrade firmware to the device. The download progress is displayed while upgrading. Click on the Start Network Upgrade link.

5) After the upgrade, the user is requested to restart the device manually.

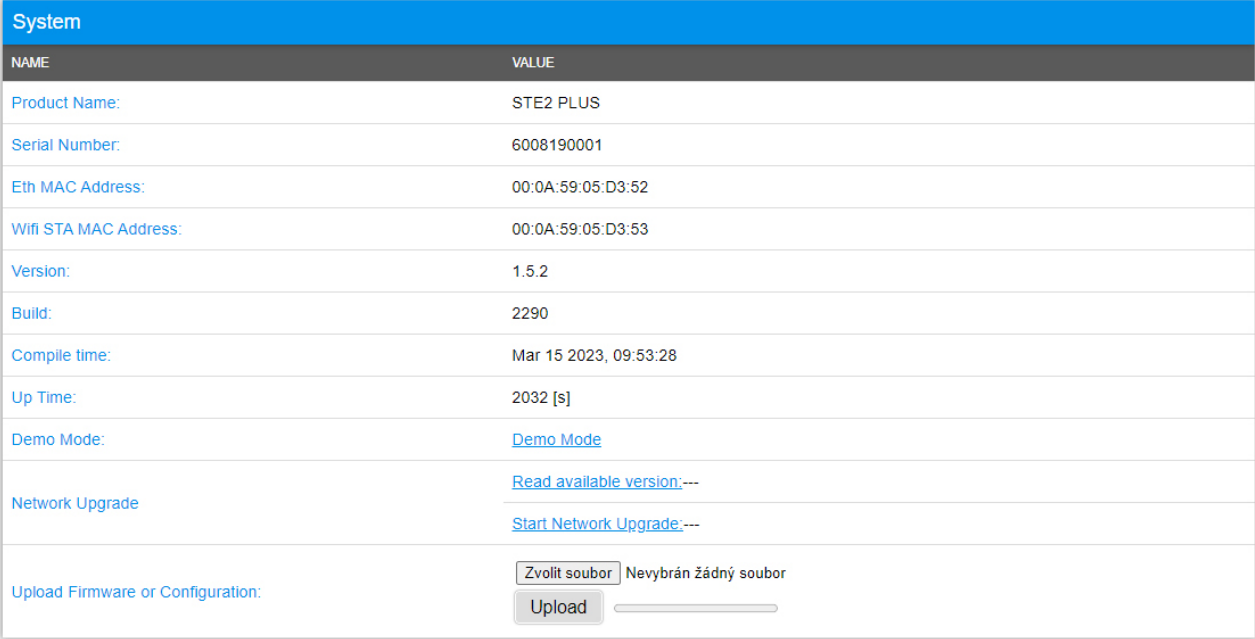

NAME	VALUE
Product Name:	STE2 PLUS
Serial Number:	6008190001
Eth MAC Address:	00:0A:59:05:D3:52
Wifi STA MAC Address:	00:0A:59:05:D3:53
Version:	1.5.2
Build:	2290
Compile time:	Mar 15 2023, 09:53:28
Up Time:	2032 [s]
Demo Mode:	Demo Mode
Network Upgrade	Read available version:--- Start Network Upgrade:---
Upload Firmware or Configuration:	<input type="button" value="Zvolit soubor"/> Nevybrán žádný soubor <input type="button" value="Upload"/> <input type="text"/>

To do this, press the Restart button. **The device will not restart automatically and this must be done manually (note: manual upload of firmware file will trigger restart automatically).**

Check the firmware version after restart.

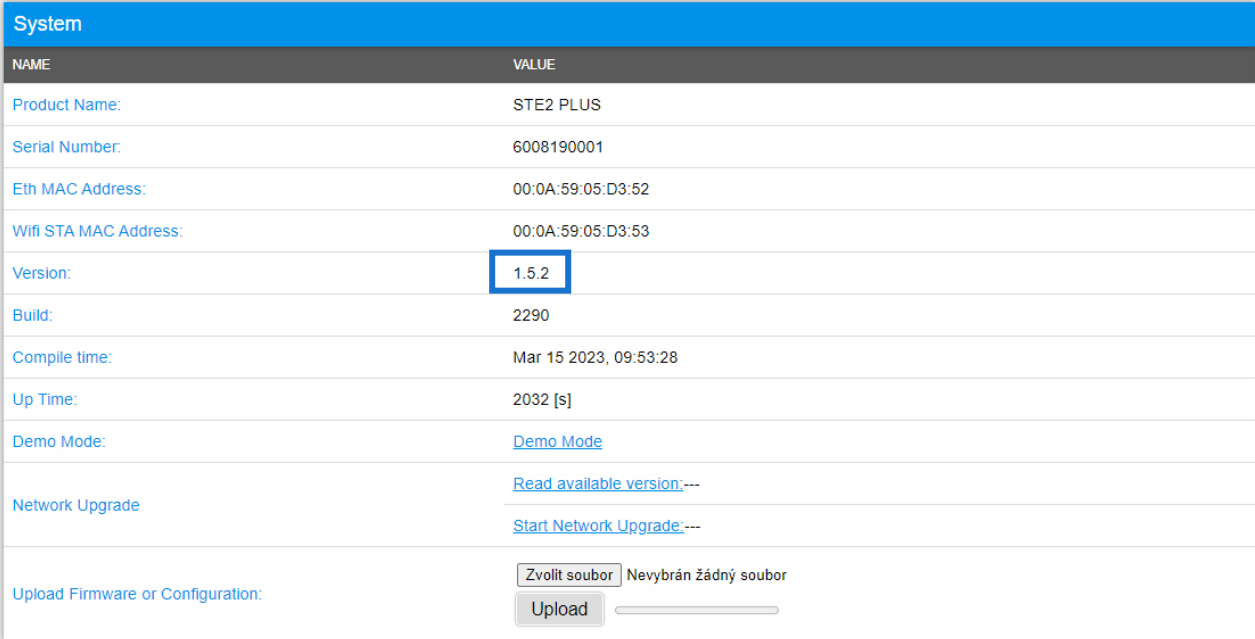

NAME	VALUE
Product Name:	STE2 PLUS
Serial Number:	6008190001
Eth MAC Address:	00:0A:59:05:D3:52
Wifi STA MAC Address:	00:0A:59:05:D3:53
Version:	1.5.2
Build:	2290
Compile time:	Mar 15 2023, 09:53:28
Up Time:	2032 [s]
Demo Mode:	Demo Mode
Network Upgrade	Read available version:--- Start Network Upgrade:---
Upload Firmware or Configuration:	<input type="button" value="Zvolit soubor"/> Nevybrán žádný soubor <input type="button" value="Upload"/> <input type="text"/>

Firmwares can be also downloaded as a file at <https://www.hw-group.com> -> [Support](#) -> [Downloads](#) -> [Firmware](#) -> [STE2 rev.2 / WLD2 / SD devices](#) (or actual fw version is available at the product web page next to the manual download).

The screenshot shows the HW group website's firmware download page. The page title is "STE2 rev.2 / WLD2 / SD devices". The navigation menu includes "Products", "Solutions", "Support", and "Contact". The "Support" menu is expanded, showing "Downloads", "Application notes", "Knowledge Base Articles", and "Supported Accessories". The breadcrumb trail is "Home > Support > Revision overview > Firmware > STE2 rev.2 / WLD2 / SD devices".

The main content area displays a list of firmware versions with the following data:

Version	Release date	File size	Download
STE2 rev.2 / WLD2 / SD devices 1.4.9	01/11/2023 - 09:30	787.2 KB	Download
Fix: Generating self-signed certificates			
STE2 rev.2 / WLD2 / SD devices 1.4.8	08/31/2022 - 08:48	787.19 KB	Download
Fix: Saving calibration values			
STE2 rev.2 / WLD2 / SD devices 1.4.7	07/29/2022 - 09:49	787.14 KB	Download
Fix: HTTPS certificate			
STE2 rev.2 / WLD2 / SD devices 1.4.6	06/22/2022 - 11:16	790.98 KB	Download
• Fix: TLS connection for Office 365			
STE2 rev.2 / WLD2 / SD devices 1.4.5 (1236)	05/18/2022 - 10:36	790.92 KB	Download
<ul style="list-style-type: none"> • Fixed non-functional autopush • Fixed non-defaulting device in situations where access to configuration was unavailable • Added support for wifi detection with WPA2/WPA3, WPA2 enterprise, WPA3 security 			

On the right side, there is a "Subscribe for software releases" form with the following fields:

- Name:
- E-mail *:
- Company:
- Operating system:
- Progr. language:

Below the form is a CAPTCHA section with the text: "This question is for testing whether or not you are a human visitor and to prevent automated spam submissions." Below this text is a small input field.



HW group, s.r.o.

Rumunská 26/122
Praha 2, 120 00
Česká republika

Tel.: +420 222 511 918
Fax: +420 222 513 833

www.HW-group.com

manual version: 1.4.0